

DNA GENERATION.

 **ceramill®**



DNA GENERATION.

POWER + DENTAL INTELLIGENCE = PERFORMANCE

Our milling machines are fully created in-house and exclusively at Amann Girrbach headquarters in Koblach, Austria. Based on our decades of experience in CNC technology and strong development skills we have the expertise to develop and manufacture our machines in-house from scratch. In-house development of all elementary components, and in particular the new control units, allows us to meticulously adapt and continually further develop our milling units to the specific requirements of dental technology. A distinctive profile emerges in terms of precision, speed and CAM processes, precisely adapted to the mechanical quality of dental materials - we call it the "Ceramill DNA".

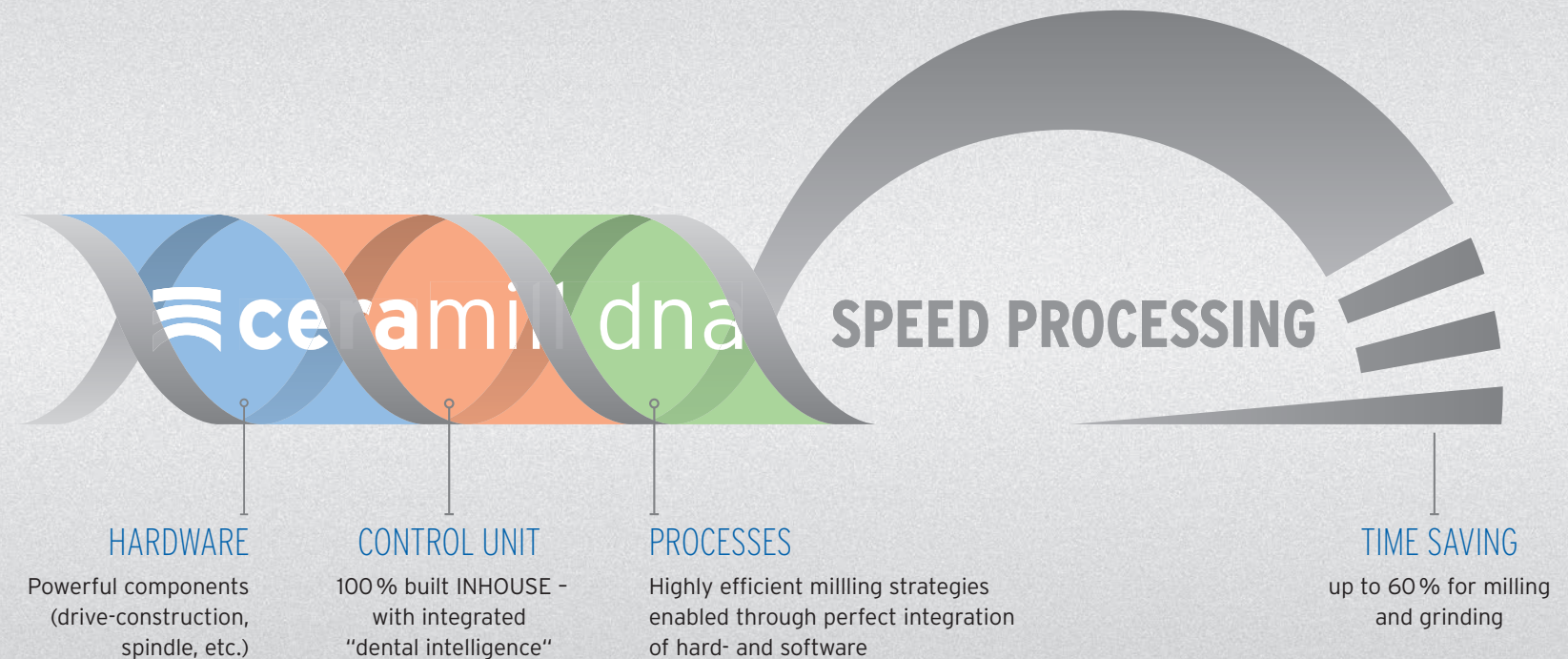

THE RIGHT CHOICE FOR EVERYONE.

SPECIALIZED

ALL-IN



ceramill® mikro



Easy entry or efficient upgrading.

- MILLING



ceramill® mikro



5-axis technology concentrated in minimum space.

- MILLING



ceramill® mikro ic



The power pack for highly efficient wet processing.

- MILLING
- GRINDING
- CARVING
- THRILLING

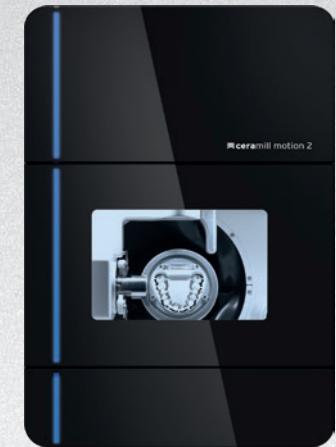

ceramill® motion 2



One for all - all in one.

- MILLING
- GRINDING
- CARVING
- THRILLING

EASY ENTRY OR EFFICIENT UPGRADING.

Ceramill Mikro is an extremely robust and compact 4-axis milling machine for dry processing blanks and single blocks such as zirconia, hybrid ceramics or dry millable composite materials. Equipped with high-performance components for permanent stability, economy and precision with low investment costs, the Mikro enables easy entry into CAD/CAM fabrication in-house in the laboratory or optimises the efficiency and productivity of the laboratory routine. With the full range of conventional laboratory indications, Ceramill Mikro 4X paves the way to profitable in-house value creation, economy and accurately fitting framework quality without preparation or reworking.

SPEED PROCESSING



- _ High Performance milling due to DNA milling strategies
- _ Easy entry or efficient upgrading thanks to low investment costs and high amortisation
- _ Highly versatile due to 4-axis dry processing of blanks and hybrid ceramic blocks
- _ Precise and durable thanks to high-quality components and robust machine design

"INTELLIGENT" 4-AXIS PROCESSING

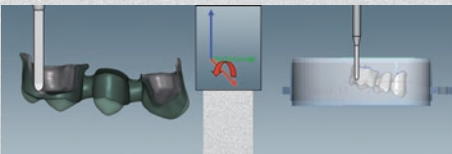

Lock the 4th axes to any desired position

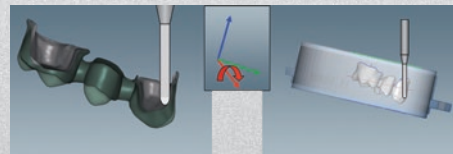

Undercuts can be milled

High-frequency spindle
extremely robust and precise

6 tool spaces
with automatic tool changer

Blank holder
conversion in only a few steps

Interior lighting
for visual control of milling

Tool length measuring unit
incl. fracture check

Presence sensor
for milling tools

**Connection for extraction protects
the internal mechanism against
contamination**
optimum with Ceramill Airstream,
but also for central extraction

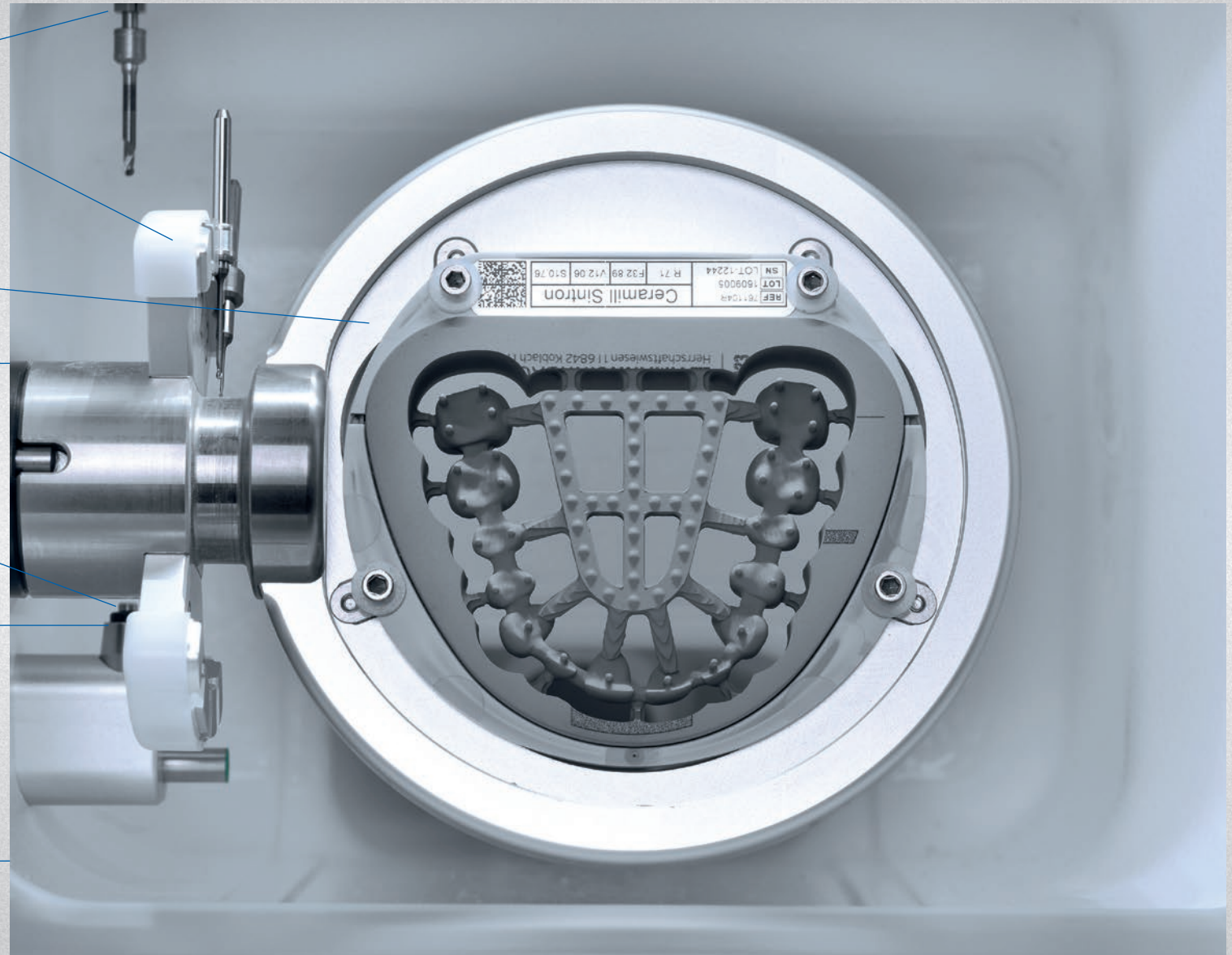

5-AXIS TECHNOLOGY CONCENTRATED IN MINIMUM SPACE.

Splints, bars, implant bridges - the 5-axis unit Ceramill Mikro 5X not only masters conventional crown and bridge work but was also designed for fabricating more complex indications with dry millable materials. The high rigidity and stability of the machine are based on the compact construction design of the sister model Ceramill Mikro 4X, without having to forego the advantages of 5-axis technology. The result is absolutely low-vibration processing, which in combination with Ceramill control technology produces impressive precision on the blank. Fast processing times, maximum quality and a wide range of indications and materials make the Ceramill Mikro 5X a genuine winner in the laboratory in terms of productivity.

SPEED PROCESSING



- _ High Performance milling due to DNA milling strategies
- _ Maximum range of indications in the 5-axis dry milling/grinding category
- _ Space-saving, compact design with the latest 5-axis technology
- _ Fast, stable and efficient thanks to low-vibration monocoque design
- _ High-quality machine components guarantee constantly high precision and durability



Standard milling strategies

5-axis exterior processing using
Ceramill CAD/CAM

High-frequency spindle
extremely robust and precise

8 tool spaces
with automatic tool changer

Blank holder
conversion in only a few steps

Interior lighting
for visual control of milling

Tool length measuring unit
incl. fracture check

Presence sensor
for milling tools

**Connection for extraction protects
the internal mechanism against
contamination**
optimum with Ceramill Airstream,
but also for central extraction



THE POWER PACK WITH THE PATENTED "CARVING MODE".

This compact 4-axis milling unit extends inhouse fabrication of conventional laboratory indications to include the option of wet grinding/milling. Titanium abutment blanks can also be processed with this unit in the same way as composites, hybrid and glass-ceramics. The monocoque design, the solidly designed axis system as well as powerful high-frequency spindles transfer the respective milling strategies precisely and at high feed speeds to the workpiece. This is particularly effective when grinding in the patented "Carving Mode". This innovative grinding process reduces the processing times of single blocks up to 60%.

With the new "Thrilling Mode", it is also possible to "thrill" block assemblies including the connection geometries from standard CAD blocks. This is yet another profitable in-house indication which finds its way back into the laboratory and expands the versatile Ceramill CAD/CAM portfolio.

- _ High Performance processing due to DNA milling/grinding strategies
- _ Carving Mode reduces processing times of blocks up to 60%
- _ Solid design enables the highest degree of precision with maximum feed rates
- _ Special holder design ensures easy handling and accuracy when processing hard materials (titanium, glass-ceramics etc.)



"Carving Mode" - excess material is being cut off as a whole

Fabrication of one-piece/
multi-piece abutments from hard
block materials

SPEED PROCESSING



Interior lighting

for visual control of milling

Super-high frequency spindle

highly precise, stable, quiet running

8 tool spaces

with automatic tool changer

Tool length measuring unit

incl. fracture check

Presence sensor

for milling tools

Blank holder

conversion in only a few steps

Coolant supply tank connection

large volume capacity ensures
long operating cycles

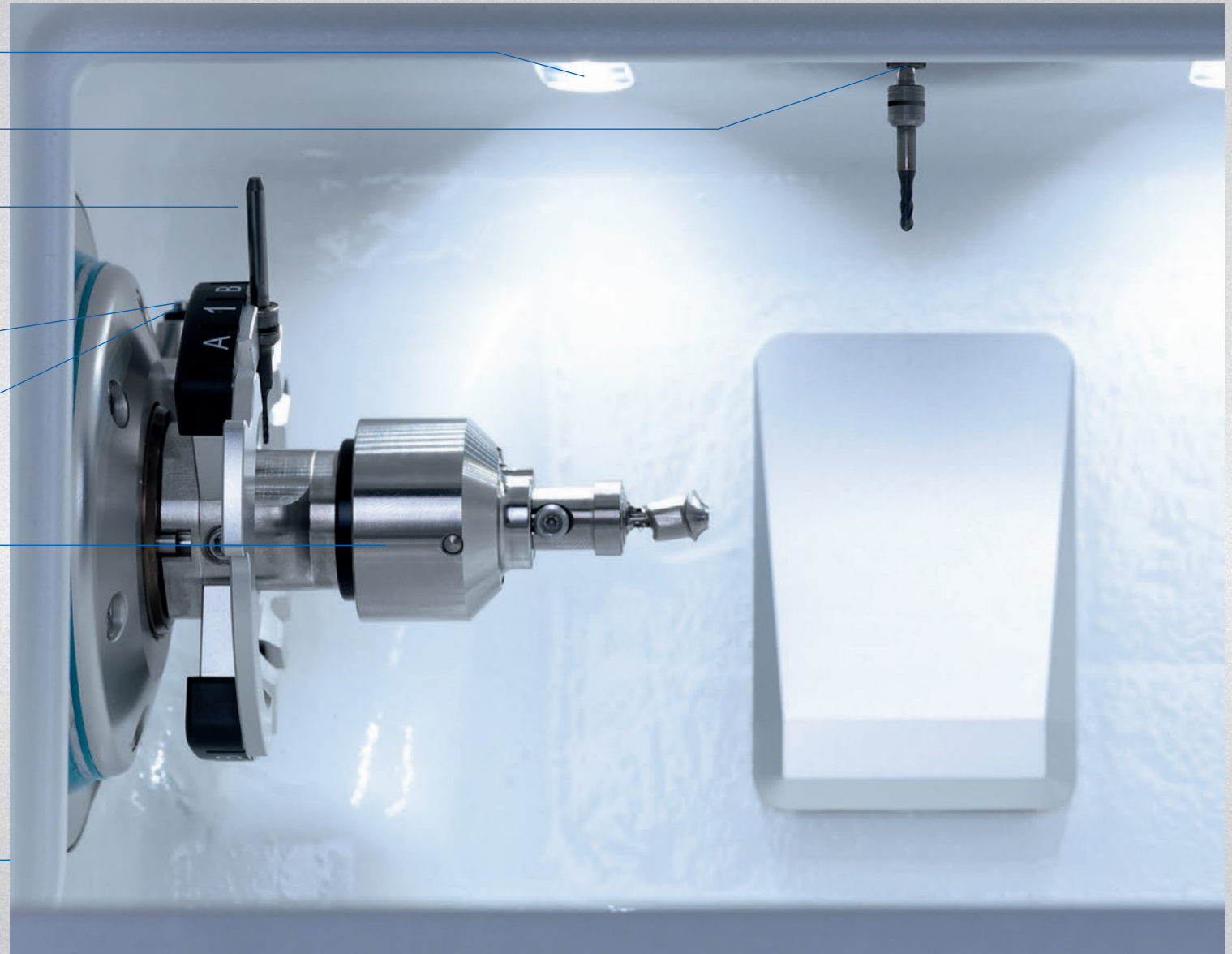

ONE FOR ALL - ALL IN ONE.

The Ceramill Motion 2 is a benchmark in terms of the range of indications and materials in-house. The 5-axis milling unit combines wet and dry processing in one unit and enables the value-creation chain to be kept virtually completely in-house in the laboratory. The Ceramill Motion 2 can be used either as a purely dry or wet unit or in combined operation for an unlimited range of materials and indications.

Equipped with the innovative control technology and robust machine concept from Amann Girrbach, the Ceramill 2 is guaranteed to be future-proof, economic and precise.

- _ High Performance milling, grinding, carving (patented), thrilling due to DNA milling/grinding strategies**
- _ Maximum range of materials and indications thanks to 5-axis wet and dry processing in one unit**
- _ Innovative processing procedures ensure maximum ROI (e.g. rotational milling of titanium, processing of full dentures)**
- _ Intelligent machine design guarantees optimum protection of all electronic components during wet operation**

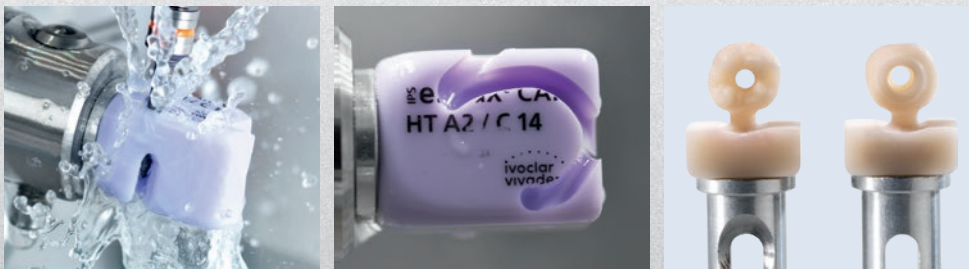

"Carving Mode" - excess material is being cut off as a whole

Fabrication of one-piece/
multi-piece abutments from hard
block materials

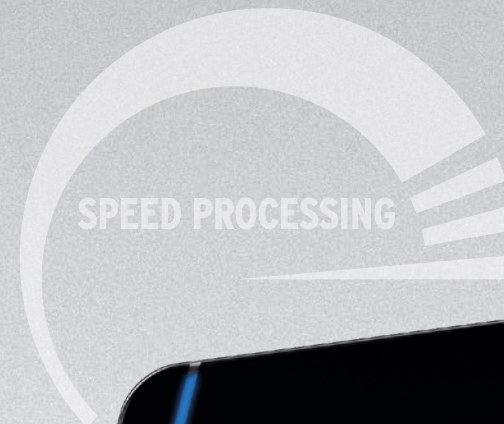

Super-high frequency spindle
highly precise, stable, quiet running

Tool length measuring unit
incl. fracture check and calibration

Blank holder
exchangeable, depending on material
or indication

6 tool spaces
with automatic tool changer

**Blank holder and wet/dry processing
mode** in only a few steps

Suction cup
for increased suction performance
and reduction of spray water

Coolant supply tank connection
large volume capacity ensures
long operating cycles



Standard milling strategies



5-axis exterior processing using
Ceramill CAD/CAM



Easy change of the blank holder
for conversion from milling to
grinding



Ceramill Coolstream - integrated
coolant preparation in the cart
and connection for the Airstream
extraction during dry processing

CNC ≠ CNC. 35 YEARS OF EXPERIENCE IN MACHINE CONSTRUCTION - CONDENSED FOR DENTAL TECHNOLOGY.

CNC-controlled dental milling units are now mainly defined by a wide range of applications and a great scope of processable materials. The quality of a CNC unit, however, is not only defined by its equipment details and versatility from a dental technology aspect. Decisive for the long-term precision and stability of a CNC unit are the structural design and reduction of moveable parts to a minimum. The more compact and low-vibration of the construction, the greater the possibility of long-term smooth operation while maintaining the necessary precision.

In addition to an intelligent design, which guarantees the stability and torsion resistance of the machine, the processing accuracy of desktop machines is decisively influenced by the quality of their construction components. Axis guidance and spindle thus contribute significantly to compensating for the forces and vibrations generated during the milling/grinding process. The components used in Ceramill CNC units are well above the load limit, independent of the material to be processed. In combination with the robust design, they ensure long-term process reliability and milling and grinding results of maximum precision.

- _ Monocoque (single-cast) design of every Ceramill unit chassis guarantees stability and torsion resistance**
- _ Hermetically sealed milling area - electronic components are optimally protected**
- _ Industrially precise axis guidance ensures mechanical rigidity due to minimum of moveable parts**
- _ Interior space made from surface-coated casting for maximum protection - comparable with industrial CNC units**



MILLING, GRINDING, + CARVING + THRILLING - POWER AND INTELLIGENCE BUNDLED FOR ULTIMATE PERFORMANCE

Our dry and wet units are equipped with quiet-running and powerful high performance spindles. Therefore maximum productivity can be achieved. Even material that is very hard to process, like hybrid ceramics or lithium disilicate, can now be processed with up to 100.000rpm which makes them the most powerful component that can be used for desktop mills. The interplay of control, drive components, spindle and tools is of key importance, as a strong performance can only be achieved in combination with correspondingly designed milling strategies. Perfectly balanced these parameters result in big savings of processing time maintaining the highest precision standard (HD milling).

The latest development resulting out of these enhancements is a brand new processing strategy we call "Carving Mode". Grinding in "Carving Mode" can result in up to 60% time savings.

With the new "Thrilling Mode", it is also possible to "thrill" block assemblies including the connection geometries from standard CAD blocks. This is yet another profitable in-house indication which finds its way back into the laboratory and expands the versatile Ceramill CAD/CAM portfolio.

- _ Hybrid bearing, high-performance, high-frequency spindle (100,000 rpm)
- _ Highly efficient processing of hybrid materials with the highest precision
- _ Reduction of grinding times up to 60%
- _ Optimally protected against dust, chips and liquids

up to
60%

saving in
time during
grinding

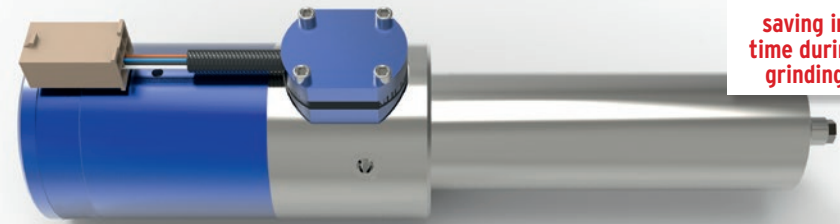

Time-consuming
parallel grinding

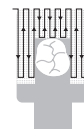

Competitor (Ø performance)

Standard grinding strategies*

Rpm: 30.000

Power: 300W



= Standard grinding

E.g. hybrid ceramics:

Ø processing time

= approx. 40 min.

Time-saving
„Carving Mode“



Ceramill DNA generation

DNA grinding strategies*

Rpm: 100.00

Power: 750W



= DNA performance grinding

E.g. hybrid ceramics:

Ø processing time

= approx. 15 min.

* Average performance data of normal market desktop mills

“CARVING” - THE QUICKEST METHOD IS USING A CURVE.

The patented “Carving Mode” - is based on the CNC technique of trochoidal milling, which Amann Girrbach transferred to the processing of dental hybrid and glass-ceramics using grinding tools. In contrast to conventional milling or grinding, the tool does not follow a linear, constant feed movement during trochoidal processing but moves over curved paths, so-called trochoids. In this way excess material is completely separated, thus avoiding grinding down the blank to the actual geometry. Low machining forces and their uniform distributions over the entire tool length enable higher processing speeds, resulting in significantly shortened fabrication times with increased service life and component quality. The procedure, unprecedented in dental CAD/CAM technology until now, results in a massive saving in time when fabricating single-tooth indications made from hybrid or glass-ceramic and corresponds to processing times using a twin spindle.

Parallel grinding
(Competitor A)

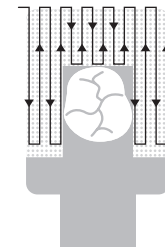

Quadrant grinding
(Competitor B)



AVERAGE GRINDING TIMES PER CROWN (MOLAR REGION)

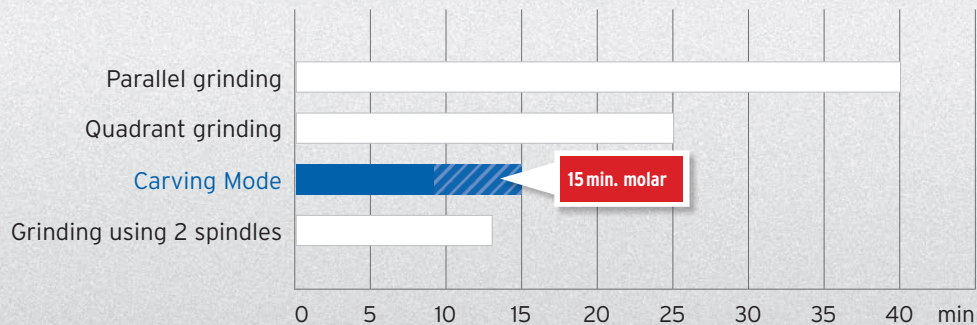

„Carving Mode“

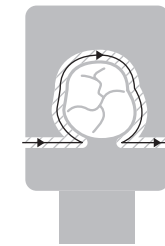

ceramill® mikro

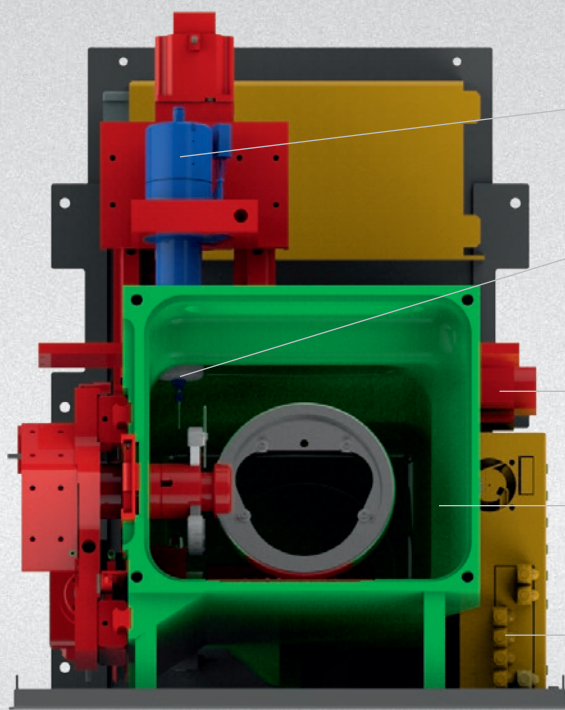

Industrial CNC guidance unit - highly precise, torsion resistant / designed with a minimum of moveable parts

Highly precise, durable spindle with a concentricity of $\leq 1\mu\text{m}$

CNC axis system designed for high loading; short processes for long-term stability

Milling area separated from the control unit to avoid dust on electronic components

Electronic components installed in the housing

Very compact machine design
D/W/H: 465 x 515 x 585 mm

515mm

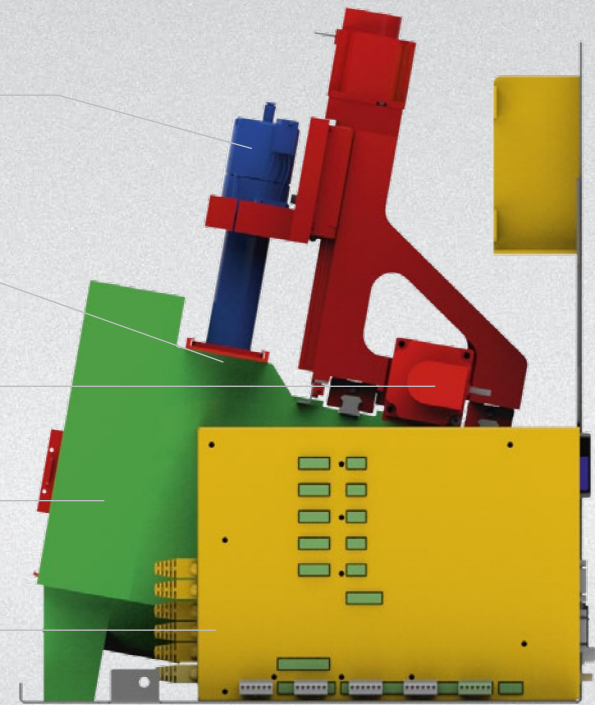

465mm

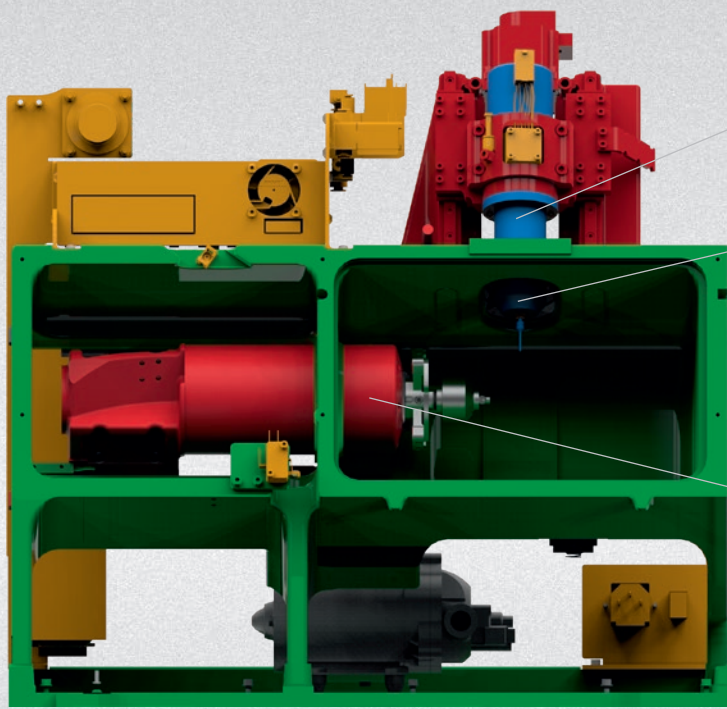

580 mm

Industrial CNC guidance unit - highly precise, torsion resistant / designed with a minimum of moveable parts

Powerful. Super-high frequency spindle with speeds up to 100,000 rpm

Milling area separated from the control unit to avoid dust on electronic components. Monocoque chassis guarantees absolute stability

Solid axis system enables high milling speeds with maximum precision

Electronic components installed in the housing

Very compact machine design
D/W/H: 465 x 580 x 585 mm

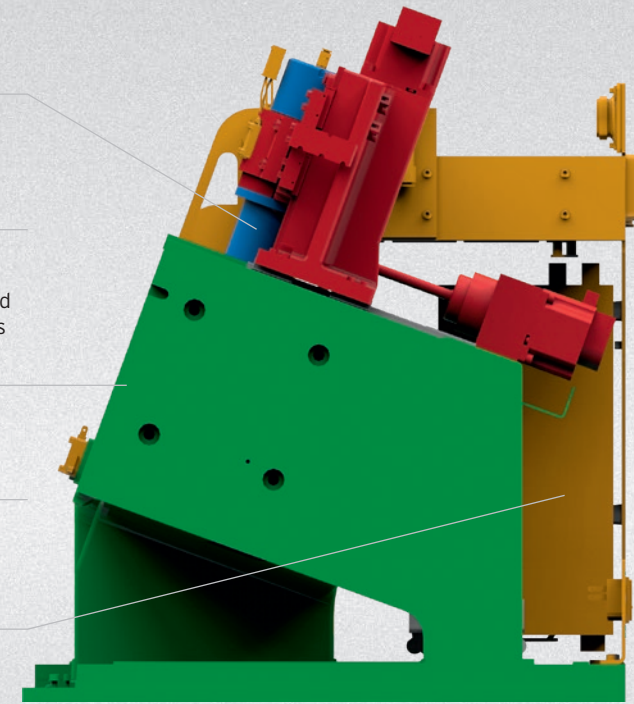

465 mm

ROTATIONAL MILLING TITANIUM ABUTMENT BLANKS. (UPGRADE)

What was only previously possible via industrial processing centres and large milling machines is now possible in the familiar high quality using the Ceramill Mikro IC and Ceramill Motion 2 with the rotational milling technique in the wet-milling mode. In contrast to conventional milling, in which the blank mainly remains in a static position, with so-called "multi-pass milling" the blank rotates continuously about its own axis. This not only saves the travel paths of the cutter, but also creates a surface quality with an equally precise and even milled surface. A special holder geometry enables the blank to be fixed, absolutely clamped and distortion-free and processed rotationally symmetric. Precise calibration guarantees that the height and angle of the custom abutment are correctly fabricated to the connection geometry.

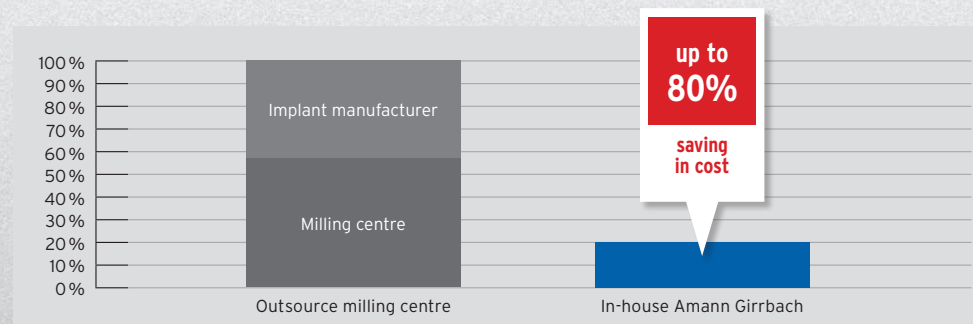
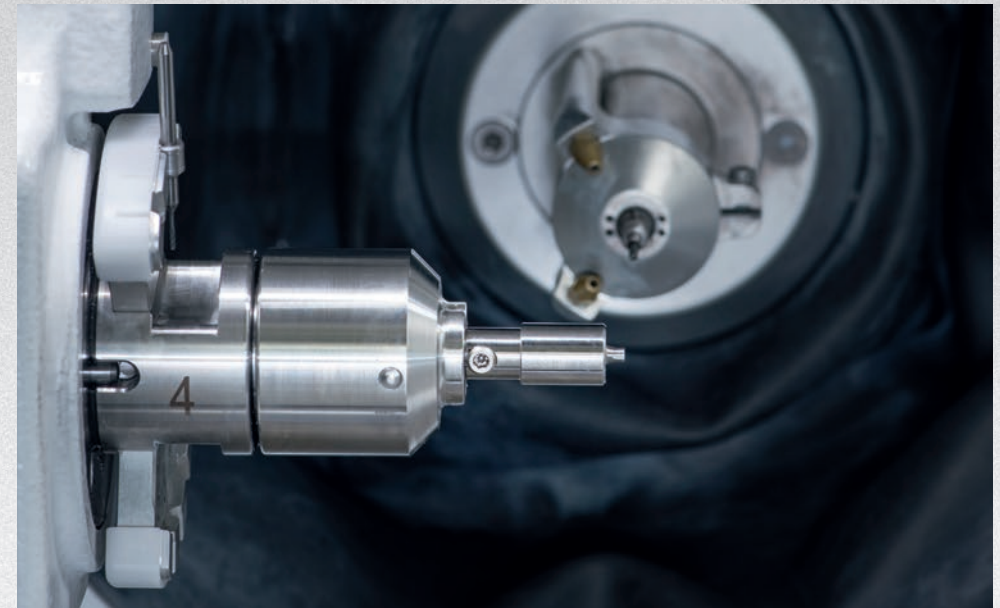

Manufacturing costs of titanium abutments

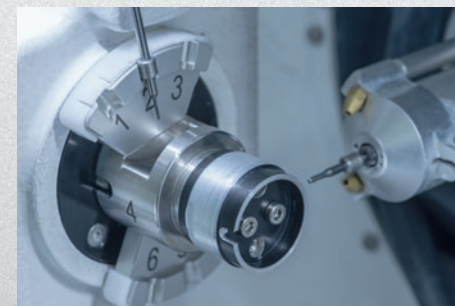

Precision calibration ensures the correct alignment of abutment and implant connection geometry

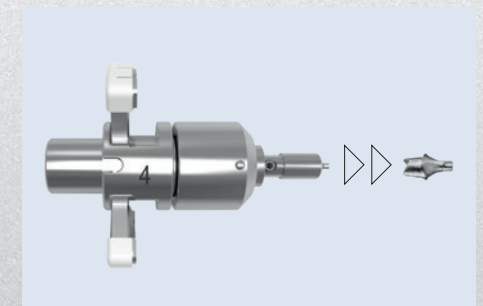

Blank holder for in-house fabrication of titanium abutments using the Ceramill Motion 2



OPEN FOR ALL.

Modular, flexible, versatile – the Plug&Play quick-change holder concept enables full exploitation of the material and indication potential of each Ceramill unit. In this way users have the option of flexibly and cost-effectively extending their milling unit to include new materials or adapting it to changing requirements. Handling is easy and uncomplicated thanks to effortless attachment of the blank holder to the connection bolts in the inside of the machine. The tool holder connected to the blank holder ensures that milling cutters or grinders for the respective material remain permanently in position.

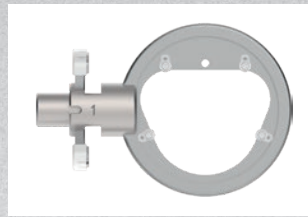

Ceramill Material 71

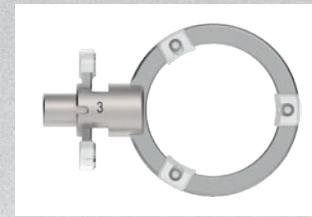

Ceramill Material 98

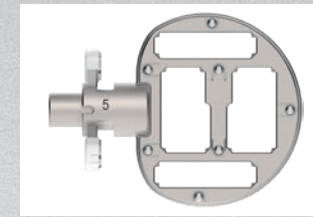

Denture teeth
(full-denture prosthetics)

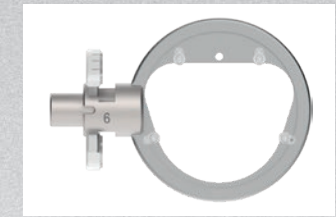

Denture wax
(full-denture prosthetics)

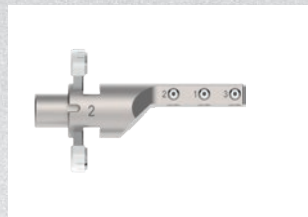

Glass-ceramic and hybrid blocks
(3-compartment)

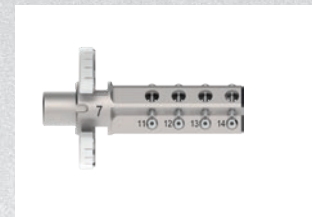

Glass-ceramic and hybrid blocks
(12-compartment)

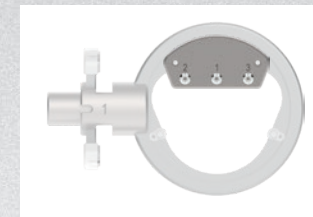

Adapter for glass-ceramic and
hybrid blocks (3-compartment)

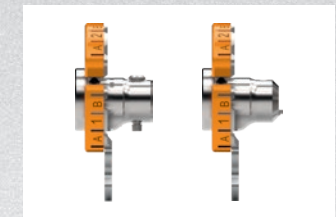

Glass-ceramic and hybrid blocks
(1-compartment), AG/UN Mandrell



Glass-ceramic and hybrid blocks
(3-compartment), AG/UN mandrel



Milling (1-compartment),
AG mandrel



Milling (3-compartment),
AG mandrel



Milling (9-compartment),
AG mandrel



Rotational milling



BD-Load

All Plug&Play quick-change holders at:
www.amangirrbach.com



MILL IN THE LABORATORY - EASILY, QUICKLY AND PRECISELY.

The automatic, clear user interface of the Ceramill Match 2 CAM software provides reliable, simple operation. Experience in CAM or milling is not required for use. Even users with little experience can easily and quickly create milling programmes for fabricating crown and bridge frameworks using the interface. An ingenious Ceramill Match 2 collision control (and collision avoidance) guarantees a high degree of process reliability.

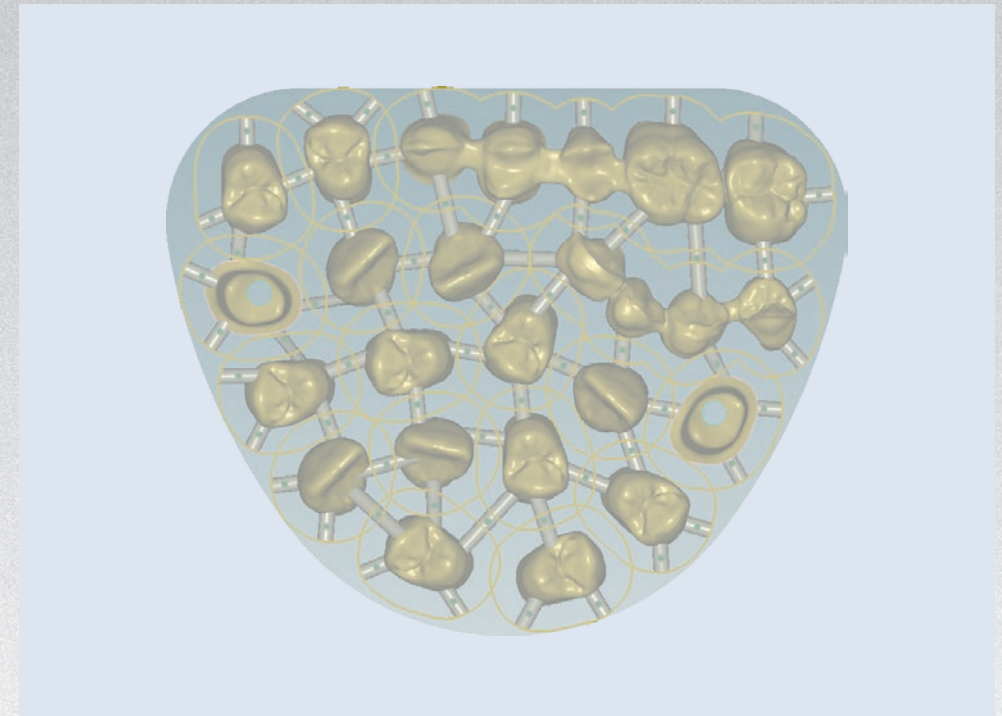

- _ Easy positioning and aligning of frameworks in the blank
- _ Easy changing of the position, size and alignment of connectors
- _ Fast calculation of milling paths
- _ Sinter cushion in thermodynamically optimum design shape for accurately fitting sintering of long-span zirconia restorations

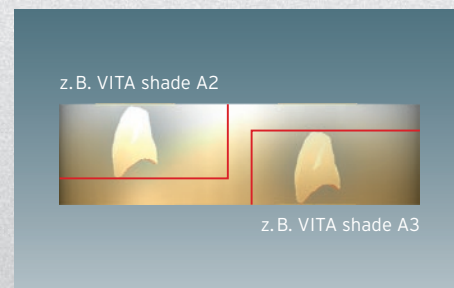

Intelligent nesting concept according to the VITA Classical shade guide

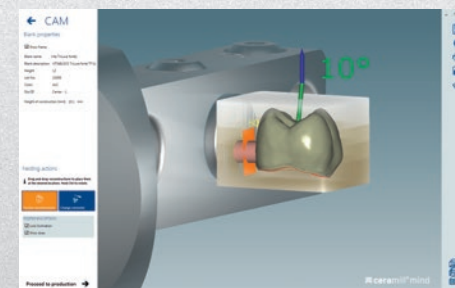

Processing of VITABLOCS® TriLux forte using rendered representation of the shade gradient

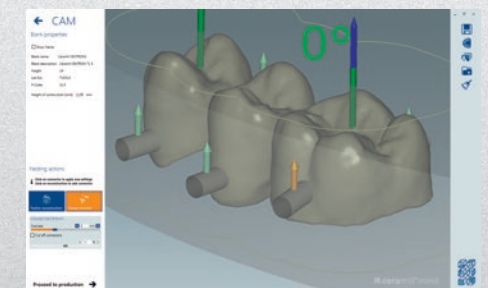

Easy positioning of the connectors on the frameworks

ENDLESS POSSIBILITIES



INDICATIONS	ceramill® mikro 4x	ceramill® mikro 5x	ceramill® mikro ic	ceramill® motion 2
Crown / bridge fully anatomical / anatomically reduced	<input type="radio"/>	<input type="radio"/>	<input type="radio"/>	<input type="radio"/>
Inlay / Onlay	<input type="radio"/>	<input type="radio"/>	<input type="radio"/>	<input type="radio"/>
Veneer	<input type="radio"/>	<input type="radio"/>	<input type="radio"/>	<input type="radio"/>
Overpress fully anatomical	<input type="radio"/>	<input type="radio"/>	<input type="radio"/>	<input type="radio"/>
Telescope crown	<input type="radio"/>	<input type="radio"/>	<input type="radio"/>	<input type="radio"/>
Attachment	<input type="radio"/>	<input type="radio"/>	<input type="radio"/>	<input type="radio"/>
Custom titanium abutment			<input type="radio"/>	<input type="radio"/>
Bridge on conical titanium bases		<input type="radio"/>		<input type="radio"/>
Multi-unit, screw-retained restoration on titanium bases		<input type="radio"/>		<input type="radio"/>
Bar on titanium bases		<input type="radio"/>		<input type="radio"/>
Bite plane		<input type="radio"/>		<input type="radio"/>
Eggshell temporary restorations	<input type="radio"/>	<input type="radio"/>	<input type="radio"/>	<input type="radio"/>
Full-denture prosthetics				<input type="radio"/>
Digital model fabrication		<input type="radio"/>		<input type="radio"/>

ceramill® mikro 4x



ceramill® mikro 5x



ceramill® mikro ic



ceramill® motion 2



MATERIAL	MATERIAL TYPE	PROCESSING WET/DRY	Dry	Dry	Wet	Dry Wet
Ceramill Sintron	CoCr sinter metal	~	○	○		○
Ceramill Zirconia	Zirconia	💧~	○	○	○*	○
Ceramill Wax	Milling wax	💧~	○	○		○
Ceramill Cast	Acrylic, transparent	💧~	○	○	○	○
Ceramill A-Temp	Acrylic, PMMA	💧~	○	○	○	○
Ceramill A-Splint	Acrylic splints, PMMA	💧~		○		○
Ceramill M-Plast	Model resin	~		○		○
Ceramill PEEK	Polymer resin	~	○	○		○
Ceramill D-Wax	Denture wax	💧				○
Ceramill D-Set	Denture teeth	💧				○
Ceramill TI-Forms	Titanium	💧			○	○
VITA SUPRINITY®	Lithium silicate ceramic	💧			○	○
VITA ENAMIC®	Hybrid ceramic	💧~			○	○
VITABLOCS® Mark II / TriLuxe forte	Fine-structure feldspar ceramic	💧			○	○
IPS e.max CAD, Ivoclar Vivadent	Lithium disilicate ceramic	💧			○	○

* coming soon

TECHNICAL DATA

	ceramill® mikro 4x	ceramill® mikro 5x	ceramill® mikro ic	ceramill® motion 2
Dimensions D/W/H (mm)	465/515/585	465/515/585	465/580/585	595/530/780
Weight	50 kg	50 kg	70 kg	78 kg
Electrical connection value	100-230V 50/60 Hz	100-230V 50/60 Hz	100-230V 50/60Hz	100-230V 50/60 Hz
Output (W)	250	250	750	750
Motor speed (rpm)	60,000 min ⁻¹	60,000 min ⁻¹	100,000 min ⁻¹	100,000 min ⁻¹
Compressed air	6 bar 50 L/min	6 bar 50 L/min	6 bar 50 L/min	6 bar 50 L/min
Torque (Ncm)	4	4	9,2	9,2
Chuck (Ømm)	3	3	3	3
Axes	4	5	4	5
Extraction	prepared	prepared		prepared
Coolant water tank			prepared	prepared

MILLING AND GRINDING TOOLS FOR CERAMILL CAD/CAM

CNC milling and grinding tools are essential components in processing dental materials. The quality, geometry, coating and number of blades of tools contribute greatly to the surface quality, detail definition and precision of a restoration. Based on this, we meticulously match our milling and grinding tools to the material-specific milling strategies, design parameters and, of course, the material itself. In this way, we not only guarantee perfect framework quality but also optimum service lives as well as smooth, efficient milling and grinding processes.

An overview, including ordering information about all Ceramill CAD/CAM milling and grinding tools can be found at:
www.amangirrbach.com



ORDERING INFORMATION

Ceramill Mikro 4X

179300N Ceramill Mikro 4X

Ceramill Mikro 5X

179330N Ceramill Mikro 5X

Ceramill Mikro IC

179600N Ceramill Mikro IC

178640 Ceramill Coolstream

Ceramill Motion 2 5X

179250N Ceramill Motion 2

178640 Ceramill Coolstream

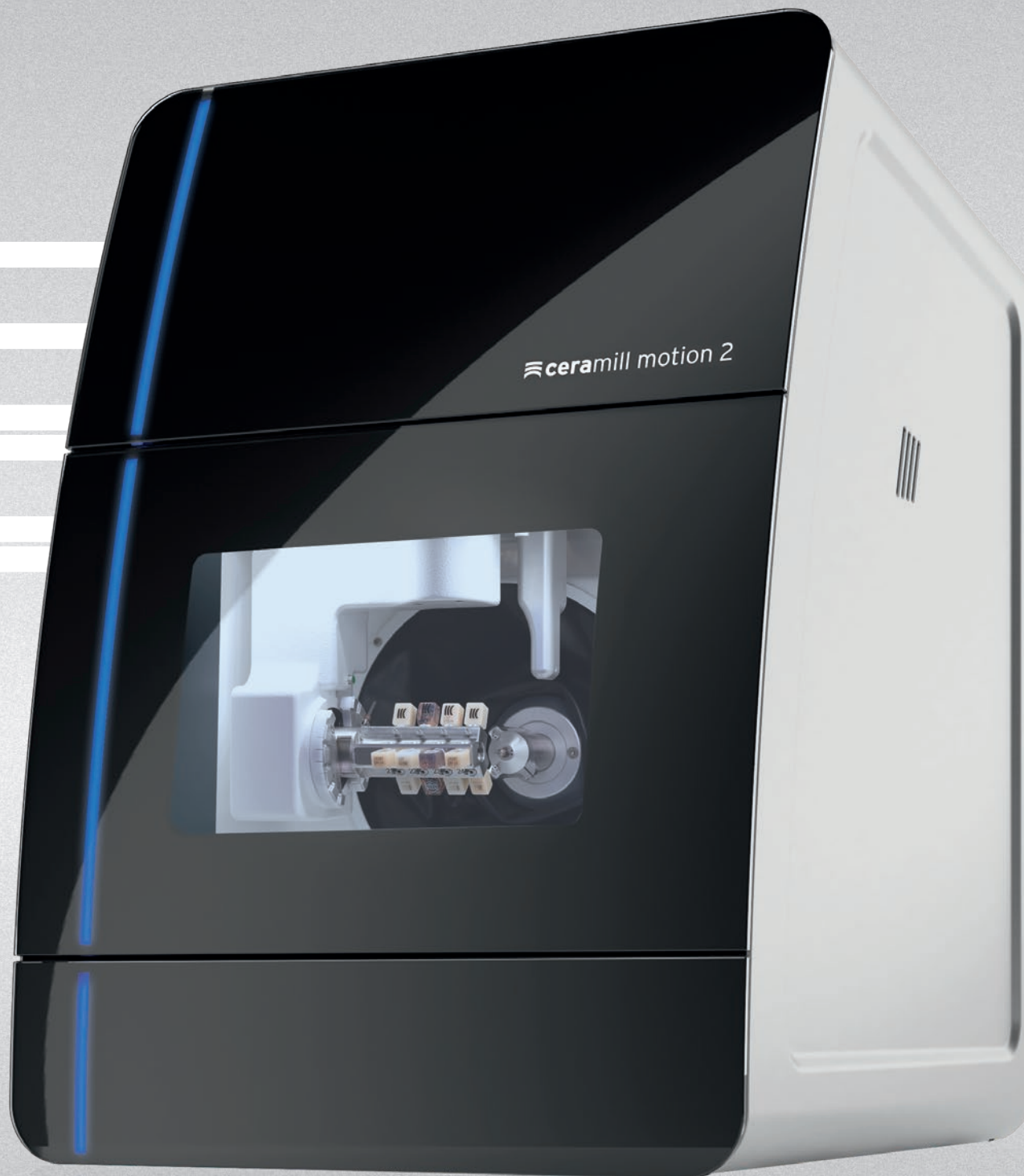

#CeramillEndOfDiscussion



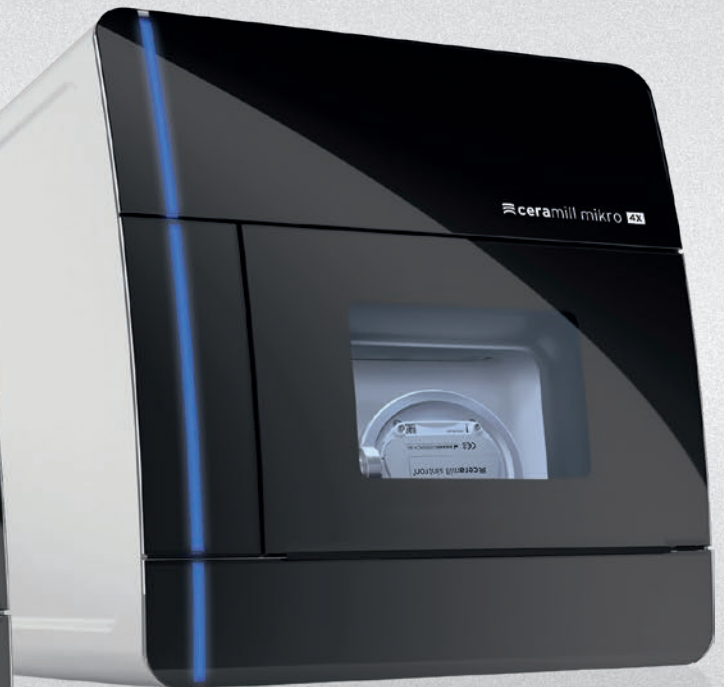
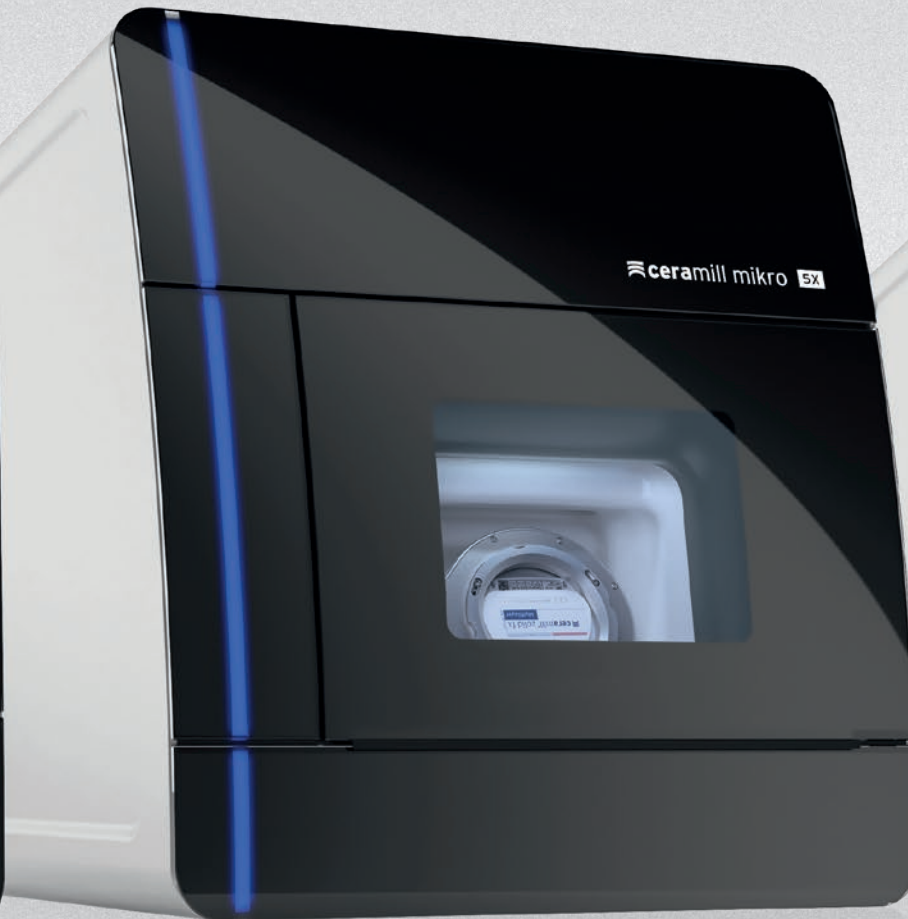



AMANNGIRRBACH

AUSTRIA (HEADQUARTERS)

Amann Girrbach AG
Koblach, Austria
Fon +43 5523 62333-105
austria@amanngirrbach.com

GERMANY

Amann Girrbach GmbH
Pforzheim, Germany
Fon +49 7231 957-100
germany@amanngirrbach.com

NORTH AMERICA

Amann Girrbach North America, LP
Charlotte, NC, U.S.A.
Fon +1 704 837 1404
america@amanngirrbach.com

BRASIL

Amann Girrbach Brasil LTDA
Curitiba, Brasil
Fon +55 41 3287 0897
brasil@amanngirrbach.com

ASIA

Amann Girrbach Asia PTE LTD.
Singapore, Asia
Fon +65 6592 5190
singapore@amanngirrbach.com

CHINA

Amann Girrbach China Co., Ltd.
Beijing, China
Fon +86 10 8886 6064
china@amanngirrbach.com

WWW.AMANNGIRRBACH.COM