

VITA IMPLANT SOLUTIONS

Working Instructions

VITA CAD-Temp® IS

VITA ENAMIC® IS



VITA shade determination

VITA shade communication

VITA shade reproduction

VITA shade control

Date of issue: 02.19

VITA – perfect match.

VITA

| | | |
|------------------------------------|--|----|
| General | VITA IMPLANT SOLUTIONS – Restoration solutions | 3 |
| | VITA IMPLANT SOLUTIONS – Block overview | 7 |
| | VITA IMPLANT SOLUTIONS – Geometric requirements for the titanium base | 8 |
| VITA CAD-Temp IMPLANT SOLUTIONS | VITA CAD-Temp – The material and its benefits | 9 |
| | VITA CAD-Temp – Indication and contraindication | 10 |
| | VITA CAD-Temp – Geometric requirements | 11 |
| | VITA CAD-Temp – Single-element solution with abutment crown (AC), step-by-step | 12 |
| | VITA ENAMIC – The material and its benefits | 29 |
| VITA ENAMIC IMPLANT SOLUTIONS | VITA ENAMIC – Indication and contraindication | 30 |
| | VITA ENAMIC – Geometric requirements, single-element solution | 31 |
| | VITA ENAMIC – Single-element solution with abutment crown (AC), step-by-step | 32 |
| | VITA ENAMIC – Geometric requirements, two-element solution | 48 |
| | VITA ENAMIC – Two-element solution with mesostructure (MS), step-by-step | 49 |
| | VITA IMPLANT SOLUTIONS – Recommended products | 68 |
| Information | VITA IMPLANT SOLUTIONS – FAQs/Information | 70 |

Information about VITA ENAMIC hybrid ceramic is available at www.vita-enamic.com

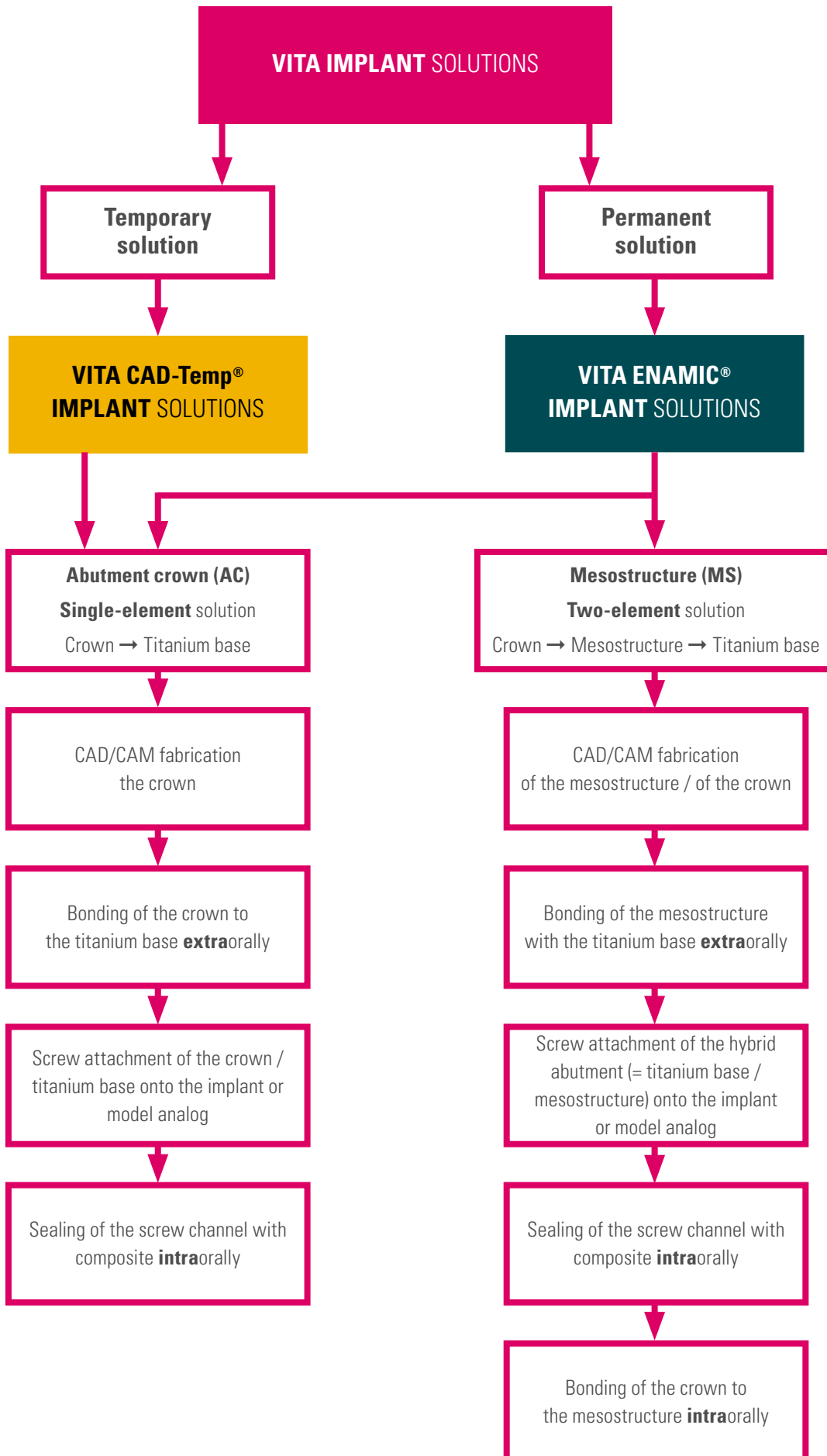

Treatment procedure: VITA IMPLANT SOLUTIONS

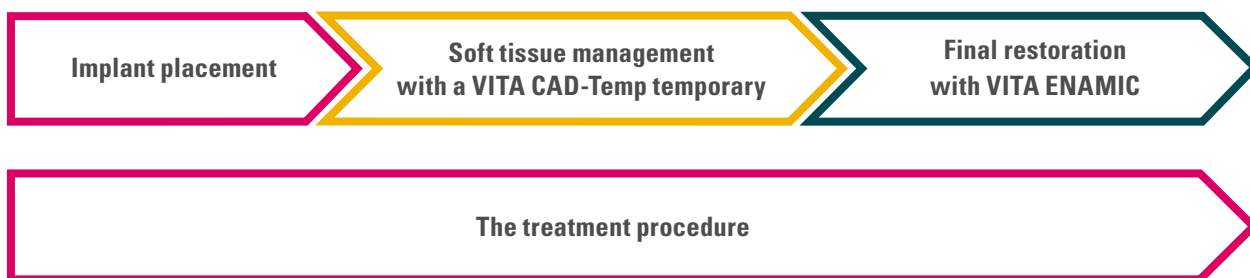

Surgical and prosthetic implant planning is carried out in accordance with the guidelines of the compatible two-element implant system used.



The prosthetic restoration of the implant can be carried out in two stages for therapeutic reasons; first, using a temporary VITA CAD-Temp solution and then using a permanent restoration, or alternatively, directly using a permanent VITA ENAMIC or VITA SUPRINITY PC restoration.







When restoring dental implants in the esthetic zone, soft-tissue management plays a critical role in successful long-term esthetics. In addition to surgical modification of the gingiva, the temporary also plays a crucial role [1]. In addition to restoration in terms of masticatory function, the implant-supported temporary also facilitates active contouring of the soft tissue in the peri-implant area, in order to shape an optimum emergence profile. The VITA CAD-Temp IMPLANT SOLUTIONS blanks support rapid and cost-effective temporary restoration of your implant work. During the prosthetic phase, enossal implants often show signs of remodeling of the peri-implant hard tissue [2]. Due to the localized bone loss that occurs as a result, the soft-tissue gradient changes so that the temporary must be adapted during the course of treatment in order to facilitate stable and esthetically optimized preconditions for the permanent restoration. The clinically proven VITA CAD-Temp material allows base areas to be supplemented in durable and hygienic fashion using the light-curing microparticle composite VITA VM LC/VITA VM LC flow, providing optimum support for this requirement. As a result, revision of the permanent restoration, which is generally complicated or impossible from a technical standpoint, is avoided.

Following the conclusion of bone remodeling and the desired shaping of the peri-implant emergence profile, an ideal option is permanent restoration using VITA ENAMIC, which is well-suited to dental implants, thanks to its absorbent properties.

- [1.] Martin WC, Pollini A, Morton D. The influence of restorative procedures on esthetic outcomes in implant dentistry: a systematic review. *Int J Oral Maxillofac Implants.* 2014;29 Suppl:142-54. doi: 10.11607/jomi.2014suppl.g3.1. Review.
- [2.] Fickl S, Zühr O, Stein JM, Hürzeler MB. Peri-implant bone level around implants with platform-switched abutments. *Int J Oral Maxillofac Implants.* 2010 May-Jun;25(3):577-81.

| | Two-element solution with mesostructure (MS) | Single-element solution with abutment crown (AC) |
|---------------------------|--|--|
| Indication | <ul style="list-style-type: none"> • Solution for situations with a significant implant axis deviation (angle correction $\leq 20^\circ$ with regard to the implant axis), in which the opening of the screw channel would be located in the vicinity of contact points or surfaces with masticatory function. • Balancing the tooth axis in the case of significant asymmetries: in other words, when the implant axis is in an off-centered position in the tooth gap. • In cases where a single-element solution is not possible, due to the insertion axis. • Better suited to anterior restorations. | <ul style="list-style-type: none"> • Solution for situations with an optimum axis position where the implant axis deviates only slightly, or not at all, from the tooth axis and where the opening of the screw channel is not located in the vicinity of contact points or surfaces with masticatory function. • Better suited to posterior crown restorations. |
| Technical characteristics | <ul style="list-style-type: none"> • Without screw channel in crown. • Adhesive joint between abutment and crown. • Extraoral removal of excess bonding material between the titanium base and the mesostructure. | <ul style="list-style-type: none"> • With screw channel in crown. • Adhesive joint not required. • Extraoral removal of excess bonding material between the titanium base and the full-contour abutment crown. |
| Luting | <ul style="list-style-type: none"> • Intraoral bonding of the crown with the mesostructure. • If the marginal edge of the mesostructure is located in the gingival or supragingival area, this makes seating and the removal of excess material easier during intraoral bonding of the crown with composite. | <ul style="list-style-type: none"> • Due to the screw attachment, an adhesive joint is not required in the sulcular area of the implant. • Screw attachment of the crown enables clinical reversibility where required. |

| Structural element | Two-element solution with mesostructure (MS) | Single-element solution with abutment crown (AC) |
|-------------------------------------|---|---|
| VITA IMPLANT SOLUTIONS Blank |  |  |
| Mesostructure |  | <p style="text-align: center;">-</p> |
| Abutment crown | <p style="text-align: center;">-</p> |  |
| TiBase titanium base |  |  |
| Superstructure |  |  |
| Implant screw |  |  |
| Implant |  |  |

| Block label / connection size / block dimensions | VITA CAD-Temp IMPLANT SOLUTIONS | VITA ENAMIC IMPLANT SOLUTIONS |
|--|---|---|
| IS-14S (12 x 14 x 18 mm) | - |  |
| IS-14L (12 x 14 x 18 mm) | - |  |
| IS-16S (16 x 18 x 18 mm) |  |  |
| IS-16L (16 x 18 x 18 mm) |  |  |
| Block shades | IS-16S, IS-16L: 1M2, 2M2, 3M2 | <p>IS-14S, IS-14L (translucent) 1M1-T, 1M2-T, 2M2-T, 3M2-T, 4M2-T</p> <p>IS-16S, IS-16L (highly translucent) 1M1-HT, 1M2-HT, 2M2-HT, 3M2-HT, 4M2-HT</p> |

Note: When using a TiBase titanium base from Sirona, the size of the interface to the TiBase (S or L) must be taken into consideration when selecting the block.

Geometric requirements for the titanium base

⚠ **Note:** Please observe the information provided by the respective manufacturers with regard to using the titanium bases.

The following points need to be observed:

- The diameter or the size must be adapted to the clinical situation and to the implant system selected.
- The titanium base may only be processed if the specifications of the respective manufacturer are observed.
- The geometric requirements for safe structural stability of the crown restoration must be fulfilled.

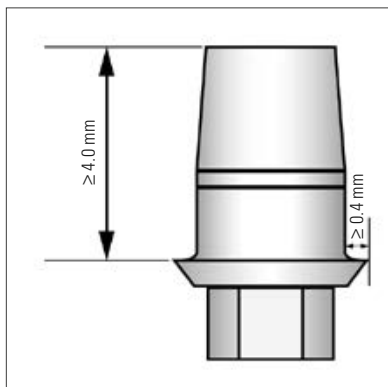

Dimensions of the titanium base

Height of adhesive surface: **min. 4.0 mm**

Marginal shoulder width: **min. 0.4 mm**



At www.vita-zahnfabrik.com/VITA_ENAMIC_IS#titan_compatibility or www.vita-zahnfabrik.com/VITA_CADTemp_IS#titan_compatibility you can find the current country-specific list of the titanium bases approved for use with the VITA IMPLANT SOLUTIONS blanks.

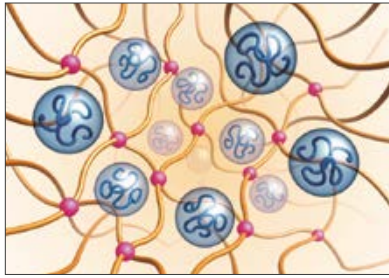

- PMMA spheres, swollen due to monomer
- cross-linked monomer
- inorganic microparticle filler material polymerized into the polymer network



- VITA CAD-Temp is a composite with 14 wt.% filler content. It is comprised of a unique fiber-free, homogeneous, highly molecular and cross-linked acrylate polymer matrix with a microparticle filler, also known as MRP material.
- In the case of the MRP material (Microfiller Reinforced Polyacrylic) developed by VITA, inorganic microfillers are industrially polymerized into the network, and a highly homogeneous, methyl methacrylate-free material is created using the unique VITA repressing process.
- As a result, there is no irritation of the gingiva by residual monomers occurs.
- Excellent shade stability and esthetics.
- Superior polishing characteristics (low plaque affinity).
- Can be individualized with the light-curing VITA VM LC/VITA VM LC flow microparticle composite.
- Allows outstanding esthetic results to be achieved with minimum effort.

VITA CAD-Temp is indicated for temporary abutment crowns on titanium bases for a clinical wearing period of up to 1 year*

Requirements for this indication:

- A reliable adhesive bond between the VITA CAD-Temp abutment crown and the titanium base:
 - Appropriate titanium base geometry (diameter, height) [1]*.
 - Avoidance of sharp margins and edges.
- Cervical support of the abutment crown on the titanium base:
 - Chamfer or rectangular shoulder with a rounded inner angle and min. width of 0.4 mm.

⚠ Notes: The processing instructions for the titanium bases are general recommendations that are not subject to a guarantee. In the event of questions regarding which titanium base is suitable for the indication in question, please contact your implant manufacturer. Strict compliance with the processing instructions provided by the manufacturer for the recommended bonding materials is crucial to clinical success.

| Overview of indications - VITA CAD-Temp IMPLANT SOLUTIONS | |
|---|---|
| Temp. anterior and posterior tooth Abutment crown |  |

Contraindication: VITA CAD-Temp IMPLANT SOLUTIONS

- Permanent restorations

[1]* Note, see page 72.

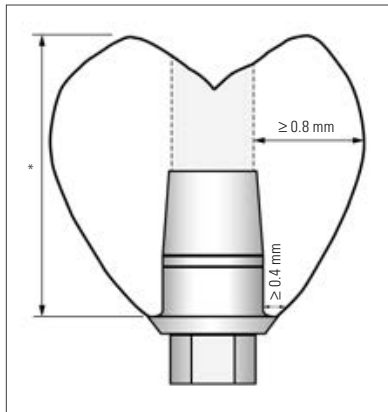

Geometric requirements for the VITA CAD-Temp® abutment crown

⚠ In order to ensure the clinical success of VITA CAD-Temp abutment crowns, the following geometries must be observed:

Circumferential wall thickness
around the titanium base:

min. 0.8 mm

Marginal shoulder width:

min. 0.4 mm

- *It is essential that the information provided by the implant manufacturer regarding the max. height of the abutment crown is observed.
- Superstructures with a highly asymmetric design and elongated extensions are contraindicated for reasons of structural stability.
- The opening of the screw channel may not be located in the vicinity of contact points or on surfaces with masticatory function; otherwise, a 2-element abutment crown with a mesostructure must be fabricated:



2-element solution (mesostructure)

Treatment procedure: VITA IMPLANT SOLUTIONS

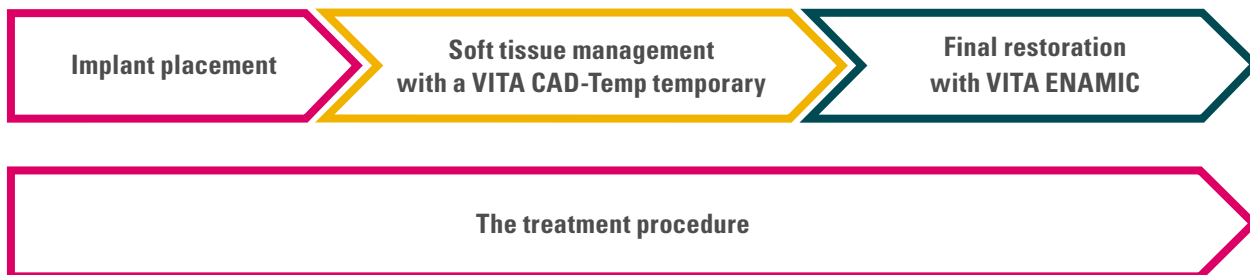

Step-by-step clinical and technical procedure using a molar crown on tooth 36 as an example

- Restoration of a Biomet Certain 3i implant

Transfer of the implant position to a digital model

This can be performed

1. by carrying out a scan on the model following conventional impression-taking (labside solution)
2. by way of intraoral scanning (chairside solution)



1. Scanning on the model

- Attach a titanium base to the corresponding laboratory analog in the master model and screw tightly using the abutment screw provided.
- Attach the scanbody provided to the titanium base, ensuring that there are no gaps.

⚠ **Note:** In doing so, pay attention to the guide groove provided. The scanbody can be scanned without powder / scan spray.

- For information on scanning, please refer to the specifications provided by the manufacturer of the CAD/CAM system.
- Scan with a white scanbody using inEos Blue or inEos X5.



2. Intraoral scan

Secure the corresponding ScanPost or TiBase titanium base to the implant using a fixation screw.

- Attach the scanbody provided to the ScanPost, ensuring that there are no gaps.

– **White scanbody for CEREC AC with Bluecam**

– **Grey scanbody for CEREC AC with Omnicam**

ScanPost is particularly suited to deep-seated implants. Please observe the information below.

- Scanbodies are available in the connection sizes S and L. The last letter in the name of the ScanPost or of the TiBase indicates the corresponding connection size (S or L). The connection size also applies to the respective block geometry (e.g., VITA ENAMIC IS-16 S or L).
- All scanbodies can be disinfected.

⚠ Note: Please observe the "ScanPost" instructions for use from Sirona, including the information on compatibility with the individual implant systems and on scanbody disinfection.

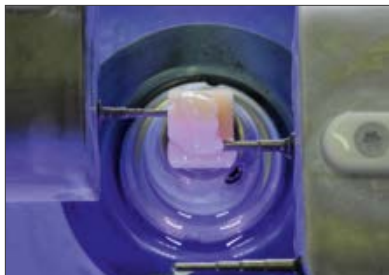

Designing the restoration

- The single-element VITA CAD-Temp crown is fabricated using a VITA CAD-Temp monoColor IS-16 block with CEREC 4.4 software or inLab 15.0 software or higher.
- A temporary VITA CAD-Temp crown is then milled in the desired shade from a VITA CAD-Temp IS-16 block (S or L, depending on the corresponding connection size).



Reworking of the VITA CAD-Temp abutment crown (extraoral)

- After the milling / grinding process, separate the sprue from the block using a diamond cutting disc and then remove using a fine-cut tungsten carbide bur while taking the shape of the emergence profile and the proximal contact points into consideration. Please ensure that at least the minimum layer thickness is observed.



- Initial preliminary verification of the fit of the abutment crown to the titanium base.

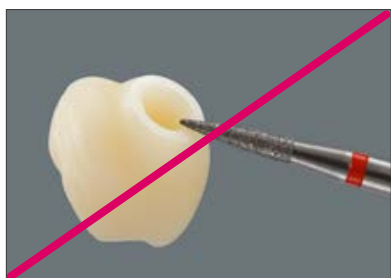

- Do not process the shoulder of the crown, as this has a negative impact on the fit to the titanium base.



- Possible inclusion of additional surface texture.



Verification of the fit between the titanium base and the VITA CAD-Temp abutment crown

- Fix the TiBase on the laboratory analog and carefully place the abutment crown on the titanium base, while taking the anti-rotation lock (groove) into account, and checking the fit closely.



Polishing

Prepolishing:

- Use a suitable silicone polisher and a small goat-hair brush.
- Use a low rotational speed: (< 5,000 rpm).

High-gloss polishing:

- Use standard commercially-available acrylic polishing agents, such as Dia Glace (Yeti), Opal polishing paste (Renfert), Dental Diamond Stick (Shofu) and Prisma Gloss (Dentsply).
- Avoid generation of excessive heat!

⚠ Note: Careful polymerization and polishing are essential requirements in order to obtain an optimum result and prevent the formation of deposits and gingivitis.

Cleaning

- In the ultrasonic unit
- Temperature: max. 40°C.

Extraoral bonding of the titanium base with the VITA CAD-Temp abutment crown

- Precise and careful preparation of the bonding surfaces is required in order to achieve an optimum adhesive bond between the titanium base and the VITA CAD-Temp abutment crown.

⚠ Note: The diameter of the titanium base may not be reduced, for example, by grinding.



- To protect the connection surface between the implant and the titanium base, fixation of the titanium base inside a laboratory analog should be carried out.
- The contact surfaces between the titanium base and the implant may not be sandblasted or processed in any other way!
- Shortening the titanium base is not recommended!
- Prior to bonding, verify whether the VITA CAD-Temp abutment crown can be easily attached to the titanium base without any gaps.

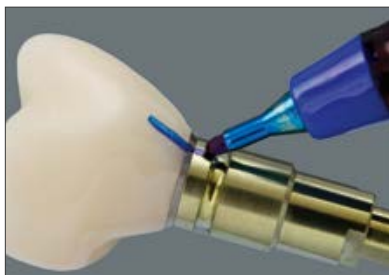

- Place the VITA CAD-Temp abutment crown on the titanium base and mark the positional relation using a waterproof pen.
- This supports correct subsequent positioning, when bonding the crown to the titanium base.
- The bonding surfaces of the VITA CAD-Temp abutment crown and the titanium base must be free from dust and grease.



- For extraoral bonding of the titanium base and the VITA CAD-Temp monoColor abutment crown, use a suitable opaque adhesive composite: Multilink Hybrid Abutment (Ivoclar Vivadent).



Conditioning the titanium base

- Protect the connection surface between the implant and the titanium base with wax or silicone. Seal the screw channel with Teflon tape. Leave some Teflon tape sticking out at the top. This allows it to be removed more easily later on.
- Use high-grade aluminium oxide (Al_2O_3) and carefully sandblast only the bonding surface of the titanium base

– Particle size: 50 μm

– Pressure: 1.5 bar

until a matte surface is obtained.



- Then remove wax or silicone. Remove the Teflon tape from the screw channel. Clean the titanium base using an ultrasonic bath, with alcohol or using a steam jet, and dry using oil-free air.



- The surface to be bonded may not be touched again after cleaning, as this can result in contamination that can have a negative impact on the subsequent adhesive bond.

- Application of a suitable bonding agent, such as Monobond Plus (Ivoclar Vivadent), using a disposable brush or microbrush.

- Apply Monobond Plus and allow to act for 60 seconds.

- Then dry with oil-free air.



⚠ Note: Please observe the instructions for use provided by the manufacturers of the respective products!

Then seal the screw channel again using a foam pellet or Teflon tape, prior to bonding with the abutment crown.





- Cleaning of the abutment crown in an ultrasonic bath, removal of grease using ethanol. Then dry with oil-free air.



- After cleaning, use a microbrush or disposable brush to thinly coat the adhesive surface with a primer, such as SR Connect (Ivoclar Vivadent) that contains MMA (methyl methacrylate), allow to act for 30 seconds and then cure with a polymerization device.

Please observe the manufacturer's instructions!



Permanent extraoral bonding of the titanium base with the VITA CAD-Temp abutment crown

⚠ Note: For bonding the titanium base to the abutment crown, please use a suitable opaque adhesive composite: Multilink Hybrid Abutment (Ivoclar Vivadent).



- Application of Multilink Hybrid Abutment (Ivoclar Vivadent) to the titanium base



- and to the bonding surface of the VITA CAD-Temp abutment crown.



- Slide the VITA CAD-Temp abutment crown slightly, rotating back and forth onto the titanium base to approx. 2/3. This way, uniform wetting of the two adhesive surfaces is ensured. Align both components in such a way that the positional markings are matched.
- Carefully slide the VITA CAD-Temp abutment crown on to the marginal end position so that the rotation and position lock of the titanium base engages in the groove of the abutment crown interface.
- While applying even contact pressure, verify both components as well as the correct positional relation in the final position:
- Smooth transition (no gaps) between the crown and titanium base!
- Remove the foam pellet from the screw channel.
- Remove any excess material in the screw channel using a microbrush.
- Carry out polymerization in accordance with the manufacturer's instructions.



- Then after curing, remove larger areas of excess bonding agent in the cervical area.



- For final curing of the adhesive composite, apply glycerin gel at the joint gap between VITA CAD-Temp and the titanium in order to prevent an oxygen inhibited layer.



- If bonding material residue is present in the screw channel, remove it using suitable rotary instruments. Do not damage the TiBase!

⚠ Note: Please observe the instructions for use provided by the manufacturers of the respective products!

Polishing of the adhesive joint



- Prepolish the adhesive joint carefully using a suitable silicone polisher and a small goat-hair brush.
- Use a low rotational speed: (< 5,000 rpm).
- Then polish to a high-gloss finish using standard commercially-available acrylic polishing agents that are also suitable for intraoral use, such as Dia Glace (Yeti), Opal polishing paste (Renfert), Dental Diamond Stick (Shofu) and Prisma Gloss (Dentsply).
- Avoid generation of excessive heat!



- Completed VITA CAD-Temp abutment crown after bonding and polishing.

Optional:



Individualization of the emergence profile of VITA CAD-Temp abutment crowns using VITA VM LC/VITA VM LC flow

- Temporaries fabricated using VITA CAD-Temp can be esthetically and / or geometrically individualized using the light-curing, indirect, microparticle veneering composite VITA VM LC/VITA VM LC flow. In other words, the emergence profile, for example, can be modified or individual layering carried out as required.



- Using a fine-cut tungsten carbide bur or diamond milling tool, roughen the surfaces of the abutment crown.
- Carefully clean the roughened surface (but without using a steam jet), and moisten using VITA VM LC MODELLING LIQUID in order to obtain a secure bond with the VITA CAD-Temp abutment crown.



- Application of VITA VM LC/VITA VM LC flow.
- Application is easier if the shaping instrument is moistened with a small quantity of VITA VM LC MODELLING LIQUID. Use sparingly!

⚠ Notes: Do not apply any material to the titanium base, as this impairs the fit with the implant. Do not use the liquid to dilute the materials.



- VITA VM LC Modelling Liquid is a hazardous material. Corresponding information can be found on page 71.

Polymerization:

- Information on polymerization and a list of suitable polymerization devices can be found in the Working Instructions for VITA VM LC (No. 1200)/VITA VM LC flow (No. 10384).
- Intermediate polymerization can be carried out at any time during layering. Fine-cut carbide burs must be used for all corrections of contours during individualization.

Alternative filling composite:

Individualization of the emergence profile of VITA CAD-Temp abutment crowns using a light-curing, methacrylate-based filling composite

Filling composites with a low-viscosity consistency (flowables, such as Clearfil Majesty Flow from Kuraray and Tetric Evo Flow from Ivoclar Vivadent) are particularly suitable for this purpose.

- Using a fine-cut tungsten carbide bur or diamond milling tool, roughen the surfaces of the abutment crown.
- Clean the roughened surface carefully, but do not clean with steam, and wet with suitable bonding agent.
- Application of the filling composite.

Polymerization:

Please observe the instructions for use of the manufacturers of the corresponding products!

 **Notes:** Do not apply any material to the titanium base, as this impairs the fit with the implant.



Polishing

- Prior to bonding to the abutment crown, polish proximal areas outside the mouth.

Prepolishing:

- Use a suitable silicone polisher and a small goat-hair brush.
- Use a low rotational speed: (< 5,000 rpm).

High-gloss polishing:

- Use standard commercially-available acrylic polishing agents, such as Dia Glace (Yeti), Opal polishing paste (Renfert), Dental Diamond Stick (Shofu) and Prisma Gloss (Dentsply).
- Avoid generation of excessive heat!

⚠ Note: Careful polymerization and polishing are essential requirements in order to obtain an optimum result and prevent the formation of deposits and gingivitis.



Cleaning

- Clean briefly (approx. 1 minute) in the ultrasonic unit. Cleaning for longer periods can impair the bond between VITA VM LC/VITA VM LC flow or the filling composite with VITA CAD-Temp.
- Temperature: max. 40°C.

Overview of the process steps for extraoral bonding of the VITA CAD-Temp crown with a titanium base

| | Process steps | VITA CAD-Temp interface Abutment crown | Titanium base |
|----|--|--|---|
| 1. | Sandblasting with Al ₂ O ₃ | 50 µm, max. 1.5 bar | 50 µm, max. 1.5 bar |
| 2. | Cleaning the surface | Ethanol, allow to evaporate | Ultrasonic unit, ethanol, allow to evaporate |
| 3. | Surface conditioning | Apply SR Connect, allow to act for 30 seconds and polymerize subsequently. | Apply Monobond Plus, allow to act for 60 seconds, and blow with air |
| 4. | Adhesive bonding | Multilink Hybrid Abutment | |
| 5. | Coverage of the adhesive joint | Glycerin gel | |
| 6. | Polishing of the adhesive joint | Standard commercially-available polisher for composite/acrylics | |

⚠ Note: Please use the above adhesive products in accordance with the manufacturer's system requirements. For example, Monobond Plus (Ivoclar Vivadent) only in combination with Multilink Hybrid Abutment (Ivoclar Vivadent).

Disinfection/sterilization

Prior to seating, it is recommended to disinfect VITA CAD-Temp crowns with an ethanol-containing surface disinfectant or to sterilize them. The local legal regulations and hygiene standards applicable to dental practices need to be observed.

Steam sterilization can be carried out with three-times fractionated prevacuum, and the following parameters need to be adhered to:

- Sterilization time: 10 minutes
- Steam temperature: 134° C/ 273° F

The abutment crown needs to be seated immediately after sterilization and may not be stored temporarily!

⚠ Please note:

The user/dentist is responsible for the sterility of the VITA CAD-Temp abutment crown.

It must be ensured that only suitable equipment and materials, as well as product-specific validated methods, are used for sterilization. The equipment that is used should be maintained properly and serviced regularly.

Intraoral seating of the abutment crown on the implant

⚠ Note: For screw attachment with the implant, please use the tools provided by the implant manufacturer and observe the specified torques.



- Fixation of the crown on the implant.
- Manual insertion of the corresponding implant screw.
- Tightening of the implant screw using a torque wrench. Observe the specifications provided by the manufacturer!
- Ensure that the treatment area and screw channel remain dry.



- Insert a sterile wadding pellet, foam pellet or Teflon tape into the screw channel using a spherical plugger.
- Apply a bonding agent compatible with the filling composite onto the inner surfaces of the screw channel.



- Seal the screw channel with temporary filling material or filling composite, depending on the planned time in situ, in the appropriate shade.
- Verification of the proximal and occlusal contact points.

Overview of the process steps for intraoral sealing of the VITA CAD-Temp screw channel with filling composite

| Process steps | | VITA CAD-Temp Abutment crown |
|---------------|---|---|
| 1. | Protect the implant screw head | Foam pellet, Teflon tape |
| 2. | Application of bonding agent in screw channel | Bonding agent |
| 3. | Adhesive filling | Temp. filling material or filling composite* |
| 4. | Adhesive filling | Standard commercially-available polisher, polishing paste for composites / acrylics |

*Depending on the clinical time in situ of the crown



Fine morphological adjustments

- The occlusion must be completely free of interferences. Remove unwanted occlusal contacts using diamond burs (40 µm).



Finishing and polishing (intraoral)

- Prepolish the VITA CAD-Temp abutment crown with suitable silicone polishers.
- Use a low rotational speed: (< 5,000 rpm).
- Then polish to a high-gloss finish using standard commercially-available acrylic polishing agents that are also suitable for intraoral use, such as Dia Glace (Yeti), Opal polishing paste (Renfert), Dental Diamond Stick (Shofu) and Prisma Gloss (Dentsply).
- Avoid generation of excessive heat!
- Pay attention to margins and contact points when finishing and polishing the restoration. The correct speed must be ensured and generation of heat must be avoided.



Completed VITA CAD-Temp abutment crown





- VITA ENAMIC is the first hybrid dental ceramic in the world with a dual-network structure.
- In this dental material, the dominant fine-structure ceramic network (86% by wt.) is strengthened by a polymer network, with both networks fully integrated with one another.
- VITA ENAMIC is a dental hybrid material that combines the positive characteristics of a ceramic and a composite.



- VITA ENAMIC is less brittle than pure ceramic and offers better abrasion behavior than composite.
- In addition to a particularly high degree of elasticity, this hybrid ceramic also guarantees high load capacity after adhesive bonding, as well as facilitating thinner walls for minimally-invasive restorations.



- In addition, VITA ENAMIC also impresses with outstanding reliability, as well as precision, edge stability and corresponding accuracy in terms of milling results. Finally, this tooth-colored hybrid material offers material properties that are similar to those of natural dentition, and ensures a natural play of color, thanks to its excellent light transmitting properties.

- As a result, VITA ENAMIC is ideally suited to crown restorations, both on natural dentition and supported by implants.

- VITA ENAMIC demonstrates excellent compatibility with oral soft tissue.





VITA ENAMIC IMPLANT SOLUTIONS is indicated for the fabrication of mesostructures and abutment crowns on titanium bases

Requirements for this indication:

- A reliable adhesive bond between the VITA ENAMIC component and the titanium base:
 - Appropriate titanium base geometry (diameter, height)[1]*.
- General compliance with the requirements for all-ceramic restorations [2]*:
 - Avoidance of sharp margins and edges.
- Cervical support of the abutment crown on the titanium base:
 - Chamfer or rectangular shoulder with a rounded inner angle and min. width of 0.4 mm.

⚠ Note: The processing instructions for the titanium bases are general recommendations that are not subject to a guarantee. In the event of questions regarding which titanium base is suitable for the indication in question, please contact your implant manufacturer. Strict compliance with the processing instructions provided by the manufacturer for the recommended bonding materials is crucial to clinical success.

| Indication: VITA ENAMIC IMPLANT SOLUTIONS | |
|--|---|
| Anterior and posterior tooth Mesostructure |  |
| Anterior and posterior tooth Abutment crown |  |

Contraindication: VITA ENAMIC IMPLANT SOLUTIONS

- Monolithic abutment bridges
- Free-end restorations
- Parafunction (for example bruxism)

[1]*, [2]* For references, see page 72.

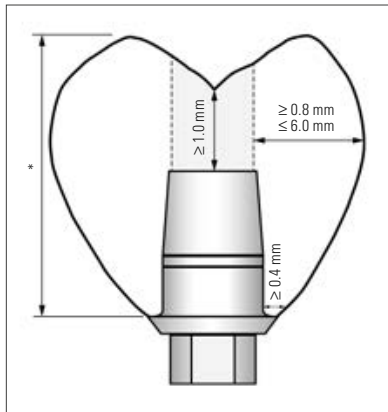

VITA ENAMIC® – geometrical requirements

Abutment crown

⚠ In order to ensure the long-term clinical success of VITA ENAMIC abutment crowns, the following geometries must be observed:

Occlusal wall thickness: **min. 1.0 mm**

Circumferential wall thickness
around the titanium base: **min. 0.8 mm**

Marginal shoulder width: **min. 0.4 mm**

- *It is essential that the information provided by the implant manufacturer regarding the max. height of the abutment crown is observed.
- Superstructures with a highly asymmetric design and elongated extensions are contraindicated for reasons of structural stability.
- The opening of the screw channel must not be in the area of contact points or on surfaces with masticatory function; otherwise, a two-part abutment crown with a mesostructure must be fabricated:



two-element solution (mesostructure)

Treatment procedure: VITA IMPLANT SOLUTIONS

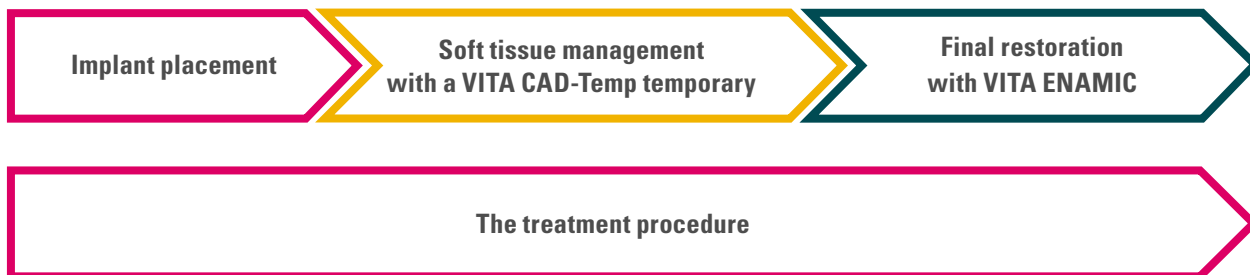

Step-by-step clinical and technical procedure using the example of a molar crown on tooth 36

Restoration of a Biomet Certain 3i implant

Transfer of the implant position to a digital model

This can be performed

1. by carrying out a scan on the model following conventional impression-taking (labside solution)
2. by way of intraoral scanning (chairside solution)



1. Scanning on the model

Attach a titanium base to the corresponding laboratory analog in the master model and screw tightly using the abutment screw provided.

- Attach the scanbody provided to the titanium base, ensuring that there are no gaps.

⚠ Note: In doing so, pay attention to the guide groove provided. The scanbody can be scanned without powder / scan spray.

- For information on scanning, please refer to the specifications provided by the manufacturer of the CAD/CAM system.
- Scan with a white scanbody using inEos Blue or inEos X5.



2. Intraoral scan

Secure the corresponding ScanPost or TiBase titanium base to the implant using a fixation screw.

- Attach the scanbody provided to the ScanPost, ensuring that there are no gaps.

– **White scanbody for CEREC AC with Bluecam**

– **Grey scanbody for CEREC AC with Omnicam**

ScanPost is particularly suited to deep-seated implants. The information provided below must also be observed.

- Scanbodies are available in the connection sizes S and L. The last letter in the name of the ScanPost or of the TiBase indicates the corresponding connection size (S or L). The connection size also applies to the respective block geometry (e.g., VITA ENAMIC IS-16 S or L).

- All scanbodies can be disinfected.

⚠ Note: Please observe the "ScanPost" instructions for use from Sirona, including the information on compatibility with the individual implant systems and on scanbody disinfection.

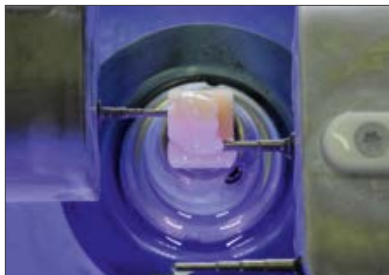

Designing the restoration

- The single-element VITA ENAMIC abutment crown is constructed using a VITA ENAMIC IS-16 block with CEREC 4.4 software or inLab 15.0 software or higher.
- A single-element VITA ENAMIC abutment crown is then milled in the desired shade from a VITA ENAMIC IS-16 block (S or L, depending on the corresponding connection size).

Reworking of the VITA ENAMIC abutment crown (extraoral)

Do not rework VITA ENAMIC restorations using carbide instruments, since these instruments may damage the material. Only diamond milling tools or the special polishing instruments provided with the VITA ENAMIC Polishing Sets (clinical or technical) may be used. For corresponding details, see the information on page 44. When reworking, slight pressure must be applied.



- After the milling process, separate the sprue from the block using a diamond cutting disc, and then remove using a fine diamond bur, while taking the shape of the emergence profile and the proximal contact points into consideration. Please ensure that at least the minimum layer thickness is observed.



- Initial preliminary verification of the fit of the abutment crown to the titanium base.

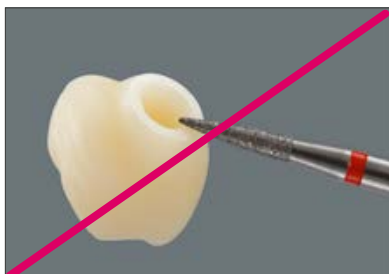

- Do not process the shoulder of the crown, as this has a negative impact on the fit to the titanium base.
- Possible inclusion of additional surface texture.





Verification of the fit between the titanium base and the VITA ENAMIC abutment crown

- Fix the TiBase on the laboratory analog and carefully place the abutment crown on a titanium base, while taking the anti-rotation lock (groove) into account, and checking the fit.



Polishing

- Prior to screw attachment of the abutment crown, polish proximal areas, in particular, outside the mouth.
- Use the instruments of the VITA ENAMIC Polishing Set technical or clinical for contouring and pre- and high-gloss polishing.

⚠ **Tip:** If Sof-Lex polishing discs are used for prepolishing, ensure that only the medium grain (M), fine grain (F) and very fine grain (SF) types are used.



⚠ **Note:** Due to the formation of dust, sintered dental ceramic products should only be ground when wet, or a face mask must be worn. Use an extraction unit in the laboratory.



Optional: shade characterization (staining technique)

- The shade of VITA ENAMIC restorations can be easily characterized (staining technique) with the special VITA ENAMIC STAINS by means of polymerization.
- Then the surface is sealed with a special varnish. For this purpose, the special VITA ENAMIC STAINS KIT, including six shades and accessories, is available.

⚠ Note: Please observe the corresponding detailed Working Instructions, No. 1931.



Optional: Individualization of the shade (layering technique) using composite

- Light-curing, methacrylate-based composites, in particular filling composites in a flowable consistency, are suitable for this purpose, as they can be easily applied and adapted to the restoration. In addition, indirect veneering composites, such as VITA VM LC flow, may also be used for extraoral applications.

⚠ Please observe the detailed working instructions, No. 10384.

- The surface of the VITA ENAMIC restoration to be individualized must first be roughened and conditioned using a suitable bonding agent. When using VITA VM LC flow in particular, the VITA ENAMIC surface is first silanized and then moistened using VITA VM LC Modelling Liquid.

Conditioning the surface

- The surface of the VITA ENAMIC restoration to be individualized must be roughened and oil-free to ensure perfect bonding to the composite.
- Adhesion of residue, such as milling liquid or lubricant (such as Dentatec) to the surface, is not permitted. Remove these either by spraying off or using an ultrasonic bath.
- The level of surface roughness immediately following CAM processing is sufficient for individualization. If subsequent reworking of the surface has reduced the level of roughness, the following three methods can be used to increase roughness again:



- Roughen using a diamond bur.
- Sandblasting using Al_2O_3 (max. 50 μm) and at a blasting pressure of max. 1 bar.
- Etch with 5% hydrofluoric acid gel, such as VITA ADIVA CERA-ETCH as follows:

Using a small disposable brush, apply VITA ADIVA CERA-ETCH to the surfaces to be etched.

Etching time: 60 seconds



Once the application time has come to an end, completely remove the residual acid from the etched surface by rinsing off with copious amounts of water, by cleaning thoroughly using a steam jet device, or by cleaning in an oil-free ultrasonic bath using distilled water.

Do not brush off, as this would lead to significant surface contamination.

- Surfaces sandblasted with Al_2O_3 must also be cleaned thoroughly.
- After cleaning, the surface should no longer be touched.



- Apply bonding agent to the roughened surface using a disposable brush.



- Application of the composite.

Recommended products for individualization of VITA ENAMIC restorations

| Manufacturer | Light-curing filling composites / veneering composite | Bonding agent |
|-------------------------|--|---|
| Kuraray | Clearfil Majesty Flow | Clearfil Ceramic Primer Plus |
| Ivoclar Vivadent | Tetric EvoFlow | Monobond Plus |
| 3M ESPE | Filtek Supreme XTE Flowable | Scotchbond Universal |
| VITA | VITA VM LC flow | Silanization (e.g., using VITA ADIVA C-PRIME), followed by VITA VM LC Modelling Liquid |

⚠ **Note:** Please observe the instructions for use provided by the corresponding manufacturer and ensure that your polymerization device offers the light intensity and wavelength required in order to set the composite fully.

Extraoral bonding of the titanium base with the VITA ENAMIC abutment crown

- Precise and careful preparation of the bonding surfaces is a prerequisite in order to achieve an optimum adhesive bond between the titanium base and the VITA ENAMIC abutment crown.



⚠ Note: The diameter of the titanium base may not be reduced, for example, by grinding.

- To protect the connection surface between the implant and the titanium base, fixation of the titanium base inside a laboratory analog should be carried out.
- The contact surfaces of the titanium base may not be sandblasted or processed in any other way!
- Shortening the titanium base is not recommended!
- Prior to bonding, verify whether the VITA ENAMIC abutment crown can be easily attached to the titanium base without any gaps.

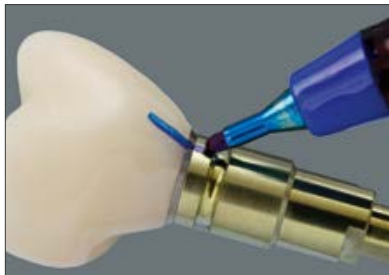

- Place the VITA ENAMIC abutment crown on the titanium base and mark the positional relationship using a waterproof pen.
- This supports correct subsequent positioning, when bonding the crown to the titanium base.
- The bonding surfaces of the VITA ENAMIC abutment crown and the titanium base must be free from dust and oil.



- For extraoral bonding of the titanium base and the VITA ENAMIC abutment crown, use an opaque adhesive composite: Multilink Hybrid Abutment (Ivoclar Vivadent).

⚠ Note: Please observe the instructions for use provided by the manufacturers of the respective products!



Conditioning the titanium base

- Protect the connection surface between the implant and the titanium base with wax or silicone. Seal the screw channel with Teflon tape. Leave some Teflon tape sticking out at the top. This allows it to be removed more easily later on.
- Use high-grade aluminium oxide (Al_2O_3) and carefully sandblast only the bonding surface of the titanium base



– Particle size: 50 μm

– Pressure: 1.5 bar

until a matte surface is obtained.

- Then remove wax or silicone. Remove the Teflon tape from the screw channel. Clean the titanium base using an ultrasonic bath, with alcohol or using a steam jet, and dry using oil-free air.



- The surface to be bonded may not be touched again after cleaning, as this can result in contamination that has a negative impact on the subsequent adhesive bond.

- Application of a suitable bonding agent, such as Monobond Plus (Ivoclar Vivadent), using a disposable brush or microbrush.

- Allow Monobond Plus to act for 60 seconds.

- Then dry with oil-free air.



⚠ Note: Please observe the instructions for use provided by the manufacturers of the respective products!



- Then seal the screw channel again using a wadding pellet or Teflon tape, prior to bonding with the VITA ENAMIC abutment crown.

Conditioning the VITA ENAMIC abutment crown

- Cover any polished outer surfaces, as needed, in order to avoid accidental etching.



- Apply VITA ADIVA CERA-ETCH (hydrofluoric acid gel, 5%) to the surfaces to be bonded.

Etching time: 60 seconds

- Completely remove any remaining acid by using water spray or clean in the ultrasonic bath.



- Then dry with oil-free air. After drying, the etched surfaces have a whitish opaque appearance.



- Apply silane bonding agent (such as Monobond Plus from Ivoclar Vivadent) to the etched surface.
- Allow the silane bonding agent to act and let it dry completely.
- After this preliminary treatment, it is essential that all contamination of the bonding surface is avoided in order to prevent any negative impact on adhesive bonding.

⚠ Note: Please observe the instructions for use provided by the manufacturers of the respective products!

Permanent extraoral bonding of the titanium base with the VITA ENAMIC abutment crown



- Precise and careful preparation of the bonding surfaces is a prerequisite in order to achieve an optimum adhesive bond between the titanium base and the VITA ENAMIC abutment crown.

⚠ **Note:** In order to bond the titanium base with the abutment crown, please use a suitable opaque adhesive composite based on methacrylate: Multilink Hybrid Abutment (Ivoclar Vivadent).



- Application of the adhesive composite (e.g., Multilink Hybrid Abutment) to the titanium base



- and to the interface of the VITA ENAMIC abutment crown.

⚠ **Note:** Please observe the instructions for use provided by the manufacturers of the respective products!



- Slide the VITA ENAMIC abutment crown slightly, rotating back and forth onto the titanium base to approx. 2/3. This way, uniform wetting of the two adhesive surfaces is ensured. Align both components in such a way that the positional markings are matched.
- Carefully slide the VITA ENAMIC abutment crown on to the marginal end position so that the rotation and position lock of the titanium base engages in the groove of the abutment crown interface.
- While applying even contact pressure, verify both components, as well as the correct positional relationship, in the final position:
- In doing so, do not damage the titanium base.
- Smooth transition (no gaps) between the crown and titanium base!
- Remove the foam pellet from the screw channel.
- Remove any excess material in the screw channel using a microbrush.
- Carry out polymerization in accordance with the manufacturer's instructions.



- Then after curing, remove larger areas of excess bonding agent in the cervical area.



- For final curing of the adhesive composite, apply glycerin gel in the joint gap between VITA ENAMIC and the titanium in order to prevent an oxygen inhibited layer.



- If bonding material residue is present in the screw channel, remove it using suitable rotary instruments. Do not damage the TiBase!



Polishing of the adhesive joint

- Using the instruments provided with the VITA ENAMIC Polishing Sets and at a low speed (< 5,000 rpm), carefully prepolish the adhesive joint and polish to a high-gloss finish.

Overview of the process steps for extraoral bonding of the VITA ENAMIC abutment crown with a titanium base

| Process steps | Interface VITA ENAMIC abutment crown | Titanium base |
|--|---|---|
| 1. Sandblasting with high-grade aluminum oxide (Al ₂ O ₃) | – | 50 µm, max 2.0 bar |
| 2. Cleaning the surface | Ethanol, allow to evaporate | Ultrasonic unit, ethanol (allow to evaporate) |
| 3. Etching (extraoral) | VITA ADIVA CERA-ETCH, 5% HF, 60 s | – |
| 4. Cleaning the surface | Use water, either by spraying off or in an ultrasonic bath | – |
| 5. Conditioning/silanizing | Apply Monobond Plus, allow to act for 60 seconds, and blow with air | Apply Monobond Plus, allow to act for 60 seconds, and blow with air |
| 6. Adhesive bonding | Multilink Hybrid Abutment | |
| 7. Coverage of the adhesive joint | VITA ADIVA OXY-PREVENT | |
| 8. Polishing of the adhesive joint | VITA ENAMIC POLISHING SET | |

⚠ Note: Please use the above adhesive products in accordance with the manufacturer's system requirements. For example, Monobond Plus (Ivoclar Vivadent) only in combination with Multilink Hybrid Abutment (Ivoclar Vivadent).

Disinfection/sterilization

Prior to seating, it is recommended to disinfect VITA ENAMIC abutment crowns with an ethanol-containing surface disinfectant or to sterilize them. The local legal regulations and hygiene standards applicable to dental practices need to be observed.

Steam sterilization can be carried out with three-times fractionated prevacuum, and the following parameters need to be adhered to:

- Sterilization time: 10 minutes
- Steam temperature: 134° C/ 273° F

The abutment crown needs to be seated immediately after sterilization and may not be stored temporarily!

Please note:

The user/dentist is responsible for the sterility of the VITA ENAMIC mesostructure.

It must be ensured that only suitable equipment and materials, as well as product-specific validated methods, are used for sterilization. The equipment that is used should be maintained properly and serviced regularly.

Seating the VITA ENAMIC abutment crown

Conditioning the screw channel in the crown



- Careful application (only in the screw channel) of VITA ADIVA CERA-ETCH (hydrofluoric acid gel, 5 %) using a disposable brush or microbrush.

 **Note:** VITA ADIVA CERA-ETCH may only be used for extraoral applications!

- Etching time: 60 seconds
- Completely remove any remaining acid by using water spray (60 sec) or clean in the ultrasonic bath. Then dry with oil-free air for 20 seconds.
- Apply silane (e.g., VITA ADIVA C-PRIME, VITA) to the etched surfaces and allow to evaporate.

Intraoral seating of the abutment crown on the implant



- Fixation of the crown on the implant.
- Manual insertion of the corresponding implant screw.



- Tightening of the implant screw using a torque wrench. Observe the specifications provided by the manufacturer!
- Ensure that the treatment area and screw channel remain dry.



- Insert a sterile wadding pellet, foam pellet or Teflon tape into the screw channel using a spherical plunger.



- Apply a bonding agent compatible with the filling composite onto the inner surfaces of the screw channel.
- Seal the screw channel with filling composite in the appropriate shade.
- Verification of the proximal and occlusal contact points.

Overview of the process steps for intraoral sealing of the VITA ENAMIC screw channel with filling composite

| Process steps | | VITA ENAMIC abutment crown |
|---------------|--------------------------------|--|
| 1. | Etching (extraoral) | VITA ADIVA CERA-ETCH 5% HF, 60 s |
| 2. | Surface conditioning | Bonding agent, compatible with the filling composite |
| 3. | Protect the implant screw head | Foam pellet, Teflon tape |
| 4. | Adhesive filling | Filling composite |
| 5. | Polishing, filling composite | e.g., VITA ENAMIC Polishing Set clinical/technical |



Fine morphological adjustments

- The occlusion must be completely free of interferences. Remove unwanted occlusal contacts using diamond burs (40 µm).



Finishing and polishing (intraoral)

- Pay attention to margins and contact points when finishing and polishing the restoration. The correct speed must be ensured and generation of heat must be avoided.

In order to achieve a natural surface shine, two steps are required.

- Prepolishing using the pink polishers of the VITA ENAMIC Polishing Set (7,000 – 10,000 rpm), while cooling with water.
- While cooling with water, polish to a high-gloss finish using the grey diamond polishers of the VITA ENAMIC Polishing Set (5,000 – 8,000 rpm).

Work using reduced contact pressure!



- ⚠ **Tip:** Final polishing to a high-gloss finish at the lowest speed and without cooling with water. If Sof-Lex polishing discs are used for finishing and prepolishing, use only the medium grain (M) and very fine grain (SF) types.



- Completed VITA ENAMIC abutment crown.

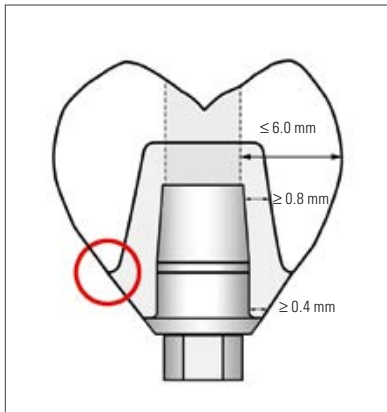

Geometry requirements for the VITA ENAMIC® mesostructure

The following points need to be observed:

- *It is essential that the information provided by the implant manufacturer regarding the max. height of the mesostructure, including the crown, is observed.
- Shaping of the mesostructure should be performed in comparable fashion to the preparation of natural dentition.
- Sharp edges and corners should generally be avoided. Ceramic-appropriate shaping!*
- Circumferential shoulder with rounded inner edges or chamfer.
- Wall thickness of the mesostructure around the screw channel: **min. 0.8 mm.**
- For self-adhesive bonding of the crown on the mesostructure, retentive surfaces and sufficient stump height must be implemented.
- Superstructures with a highly asymmetric design and elongated extensions are contraindicated for reasons of structural stability.
- As a result, the **crown width** is **limited to a 6.0 mm** circumference, with regard to the screw channel of the mesostructure.

* For corresponding details, see the brochure "Clinical Aspects of All-Ceramics," no. 1696.

Treatment procedure: VITA IMPLANT SOLUTIONS

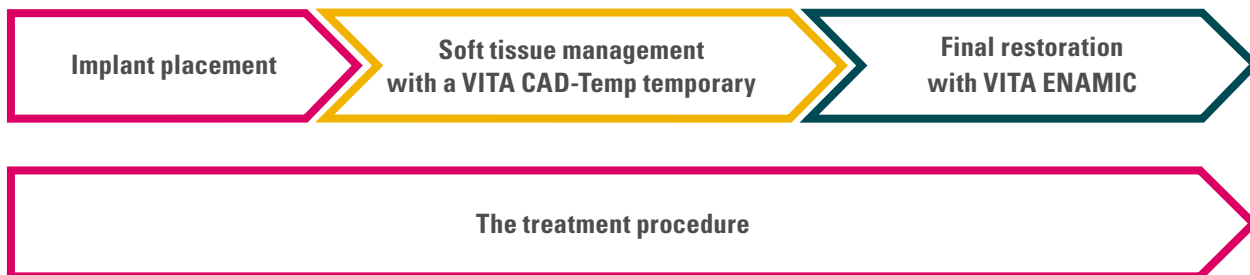

Step-by-step clinical and technical procedure using the example of an anterior crown on tooth 21.

- Restoration on a Biomet Certain 3i implant
- Mesostructure made of VITA ENAMIC, crown made of VITA ENAMIC.

Transfer of the implant position to a digital model

This can be performed

1. by carrying out a scan on the model following conventional impression-taking (labside solution)
2. by way of intraoral scanning (chairside solution)



1. Scanning on the model

- Attach a titanium base to the corresponding laboratory analog in the master model and screw tightly using the abutment screw provided.
- Attach the scanbody provided to the titanium base, ensuring that there are no gaps.

⚠ **Note:** In doing so, pay attention to the guide groove provided. The scanbody can be scanned without powder / scan spray.

- For information on scanning, please refer to the specifications provided by the manufacturer of the CAD/CAM system.
- **Scan with a white scanbody using inEos Blue or inEos X5.**



2. Intraoral scan

Secure the corresponding ScanPost or TiBase titanium base to the implant using a fixation screw.

- Attach the scanbody provided to the ScanPost, ensuring that there are no gaps.

– **White scanbody for CEREC AC with Bluecam**

– **Grey scanbody for CEREC AC with Omnicam**

ScanPost is particularly suited to deep-seated implants. The information provided below must also be observed.

- Scanbodies are available in the connection sizes S and L. The last letter in the name of the ScanPost or of the TiBase indicates the corresponding connection size (S or L). The connection size also applies for the respective block geometry (e.g., VITA ENAMIC IS-16 S or L).
- All scanbodies can be disinfected.

⚠ Note: Please observe the "ScanPost" instructions for use from Sirona, including the information on compatibility with the individual implant systems and on scanbody disinfection.

Designing the restoration

- The two-element VITA ENAMIC crown is constructed with CEREC 4.4 software or inLab 15.0 software or higher.
- A mesostructure and crown are then milled in the desired shade from a VITA ENAMIC IS-14 or IS-16 block (S or L, depending on the corresponding connection size).

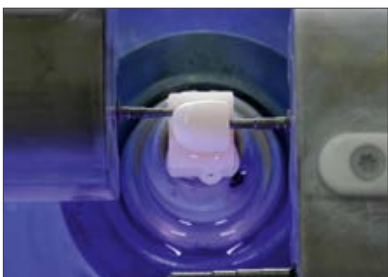
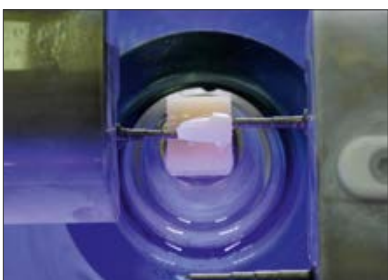

Reworking of the VITA ENAMIC mesostructure

Do not rework VITA ENAMIC restorations using carbide instruments, since these instruments may damage the material. Only diamond milling tools or the special polishing instruments provided with the VITA ENAMIC Polishing Sets (clinical or technical) may be used.

When reworking, slight pressure must be applied.



- Separation of the VITA ENAMIC mesostructure from the block.



- Fix the TiBase on the laboratory analog and fit the VITA ENAMIC mesostructure carefully to the TiBase.



- Mill the sprue carefully using a fine diamond bur, while taking the shape of the emergence profile and the shoulder into consideration.

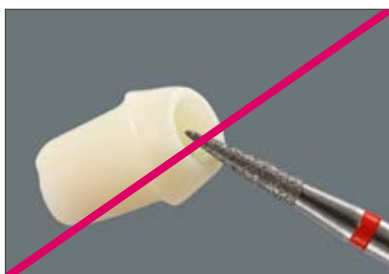

- ⚠ **Note:** Do not carry out any custom adjustments to the shape, as this has a negative impact on the fit between the mesostructure and the titanium base, or between the mesostructure and the crown.

Extraoral bonding of the titanium base with the VITA ENAMIC mesostructure

⚠ **Notes:** The diameter of the titanium base may not be reduced, for example, by grinding.

- To protect the connection surface between the implant and the titanium base, fixation of the titanium base inside a laboratory analog should be carried out.
- The contact surfaces between the titanium base and the implant may not be sandblasted or processed in any other way!
- Shortening the titanium base is not recommended!
- Prior to bonding, verify whether the VITA ENAMIC mesostructure can be easily attached to the titanium base without any gaps.
- Place the VITA ENAMIC mesostructure on the titanium base and mark the positional relationship using a waterproof pen.
- This supports correct subsequent positioning, when bonding the crown to the titanium base.
- The bonding surfaces of the VITA ENAMIC mesostructure and the titanium base must be free from dust and oil.
- For extraoral bonding of the titanium base and the VITA ENAMIC mesostructure, use Multilink Hybrid Abutment (Ivoclar Vivadent) as the bonding agent.



⚠ **Note:** Please observe the instructions for use provided by the manufacturers of the respective products!

Conditioning the titanium base



- Protect the connection surface between the implant and the titanium base with wax or silicone. Seal the screw channel with Teflon tape. Leave some Teflon tape sticking out at the top. This allows it to be removed more easily later on.



- Use high-grade aluminium oxide (Al_2O_3) and carefully sandblast only the bonding surface of the titanium base

– Particle size: 50 μm

– Pressure: 1.5 bar

until a matte surface is obtained.



- Then remove wax or silicone. Remove the Teflon tape from the screw channel. Clean the titanium base using an ultrasonic bath, with alcohol or using a steam jet, and dry using oil-free air.
- The surface to be bonded may not be touched again after cleaning, as this can result in contamination that has a negative impact on the subsequent adhesive bond.



- Application of a suitable bonding agent, such as Monobond Plus (Ivoclar Vivadent), using a disposable brush or microbrush.
- Allow Monobond Plus to act for 60 seconds.
- Then dry with oil-free air.

⚠ Note: In order to bond the titanium base with the mesostructure, please use an opaque bonding material.



- Seal the screw channel using a wadding pellet or Teflon tape, prior to bonding with the VITA ENAMIC mesostructure.

Conditioning the VITA ENAMIC mesostructure



- Prior to adhesive bonding with the titanium base, degrease the screw channel of the mesostructure using alcohol.
- Cover any polished outer surface, as needed, in order to avoid accidental etching.
- Apply VITA ADIVA CERA-ETCH (hydrofluoric acid gel, 5%) to the surfaces to be bonded.



- Etching time: 60 seconds
- Completely remove any remaining acid by using water spray or clean in the ultrasonic bath.
- Then dry with oil-free air. After drying, the etched surfaces have a whitish opaque appearance.



- Apply silane bonding agent (such as Monobond Plus from Ivoclar Vivadent) to the etched surface.
- Allow the silane bonding agent to act and let it dry completely.
- After this preliminary treatment, it is essential that all contamination of the bonding surface is avoided in order to prevent any negative impact on adhesive bonding.

⚠ **Note:** Please observe the instructions for use provided by the manufacturers of the respective products!

Extraoral bonding of the titanium base with the VITA ENAMIC mesostructure



- Precise and careful preparation of the bonding surfaces is a prerequisite in order to achieve an optimum adhesive bond between the titanium base and the VITA ENAMIC mesostructure.

⚠ **Note:** In order to bond the titanium base with the mesostructure, please use a suitable opaque adhesive composite based on methacrylate: Multilink Hybrid Abutment (Ivoclar Vivadent).



- Application of the adhesive composite Multilink Hybrid Abutment to the titanium base



- and to the interface of the VITA ENAMIC mesostructure.



- Slide the VITA ENAMIC mesostructure slightly, rotating back and forth onto the titanium base to approx. 2/3. This way, uniform wetting of the two adhesive surfaces is ensured. Align both components in such a way that the positional markings are matched.
- Carefully slide the VITA ENAMIC mesostructure on to the marginal end position so that the rotation and position lock of the titanium base engages in the groove of the mesostructure interface.
- While applying even contact pressure, verify both components, as well as the correct positional relationship, in the final position:
- In doing so, do not damage the titanium base.
- Smooth transition (no gaps) between the crown and titanium base!
- Remove the Teflon tape from the screw channel.
- Carry out polymerization in accordance with the manufacturer's instructions.
- Then after curing, remove larger areas of excess bonding agent in the cervical area.



- Remove any excess material in the screw channel using a microbrush.



- For final curing of the adhesive composite, apply glycerin gel (e.g., VITA ADIVA OXY-PREVENT) at the joint gap between VITA ENAMIC and the titanium in order to prevent an oxygen inhibited layer.

⚠ **Note:** Please observe the instructions for use provided by the manufacturers of the respective products!



Polishing the emergence profile and adhesive joint

⚠ Note: Careful polymerization and polishing are essential requirements in order to obtain an optimum result and prevent the formation of deposits and gingivitis.

- Using the instruments provided with the VITA ENAMIC Polishing Sets and at a low speed (< 5,000 rpm), carefully prepolish the emergence profile and the adhesive joint, and polish to a high-gloss finish.
- Using rotary diamond instruments, carefully remove any adhesive composite residue that may be present in the screw channel.



Overview of the process steps for extraoral bonding of the VITA ENAMIC mesostructure with a titanium base

| | Process steps | Interface VITA ENAMIC mesostructure | Titanium base |
|----|---|--|--|
| 1. | Sandblasting with high-grade aluminum oxide (Al ₂ O ₃) | – | 50 µm, max 2.0 bar |
| 2. | Cleaning the surface | Ethanol, allow to evaporate | Ultrasonic unit, ethanol (allow to evaporate) |
| 3. | Etching (extraoral) | VITA ADIVA CERA-ETCH, 5% HF, 60 s | – |
| 4. | Cleaning the surface | Use water, either by spraying off or in an ultrasonic bath | – |
| 5. | Conditioning/silanizing | Apply Monobond Plus, allow to act for 60 seconds and blow with air | Apply Monobond Plus, allow to act for 60 seconds and blow with air |
| 6. | Adhesive bonding | Multilink Hybrid Abutment | |
| 7. | Coverage of the adhesive joint | VITA ADIVA OXY-PREVENT | |
| 8. | Polishing, adhesive joint | VITA ENAMIC POLISHING SET | |

⚠ Note: Please use the above adhesive products in accordance with the manufacturer's system requirements. For example, Monobond Plus (Ivoclar Vivadent) only in combination with Multilink Hybrid Abutment (Ivoclar Vivadent).

Reworking the crown (extraoral)

Do not rework VITA ENAMIC hybrid ceramic restorations using tungsten carbide instruments, as these may damage the material. Only diamond milling tools, or for VITA ENAMIC, the special polishing instruments provided with the VITA ENAMIC Polishing Sets (clinical or technical) may be used. When reworking, slight pressure must be applied.



- Mill the block sprue using a fine diamond bur, while taking the shape of the emergence profile and the crown margin into consideration.



- Do not process the shoulder of the crown, as this has a negative impact on the fit to the mesostructure.



- **⚠ Tip:** Rework the edges of the crown with the crown in situ on the mesostructure. This allows a seamless transition between the crown and the mesostructure to be achieved.

- If there are inaccuracies in terms of the fit, corrections can be made by performing milling on the crown, but not on the mesostructure.



- Possible inclusion of additional surface texture.



- Intraoral fitting, verification of proximal contacts.

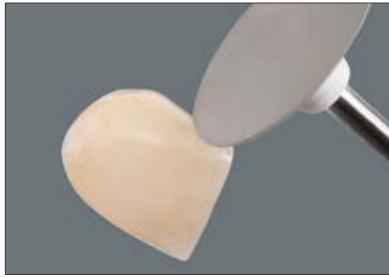

- Prior to bonding to the mesostructure, polish proximal areas outside the mouth.

The following applies specifically for VITA ENAMIC:

- Using the instruments provided with the VITA ENAMIC Polishing Sets (technical and clinical), perform prepolishing and polishing to a high-gloss finish. Observe the speed ranges in each case!
- If Sof-Lex polishing discs (3M ESPE) are used for smoothing / prepolishing, ensure that only the medium (M), fine (F), and very fine (SF) grain types are used.



VITA ENAMIC Polishing Set technical



VITA ENAMIC Polishing Set clinical

Optional: shade characterization (staining technique)

– See information on page 36.

Optional: Individualization of the shade (layering technique)

– See information on page 36.

Conditioning and seating the mesostructure and crown



- **Conditioning the VITA ENAMIC mesostructure**

- Conditioning the VITA ENAMIC surfaces is crucial for a strong adhesive bond between the VITA ENAMIC mesostructure and the hybrid ceramic crown:
- Apply VITA ADIVA CERA-ETCH (hydrofluoric acid gel, 5%) to the surfaces to be bonded.

Etching time: 60 seconds



- Completely remove any remaining acid by using water spray or clean in the ultrasonic bath.
- Then dry with oil-free air. After drying, the etched surfaces have a whitish opaque appearance.



- Apply silane bonding agent (such as ADIVA C-PRIME from VITA, Monobond Plus from Ivoclar Vivadent or CLEARFIL CERAMIC PRIMER PLUS from Kuraray) to the etched surface.
- Allow the silane bonding agent to act and let it dry completely.
- After this preliminary treatment, it is essential that all contamination of the bonding surface is avoided in order to prevent any negative impact on adhesive bonding.

⚠ **Note:** Please observe the instructions for use provided by the manufacturers of the respective products!

Disinfection/sterilization

Prior to seating, it is recommended to disinfect VITA ENAMIC mesostructures with an ethanol-containing surface disinfectant or to sterilize them. The local legal regulations and hygiene standards applicable to dental practices need to be observed.

Steam sterilization can be carried out with three-times fractionated prevacuum, and the following parameters need to be adhered to:

- Sterilization time: 10 minutes
- Steam temperature: 134° C/ 273° F

The abutment crown needs to be seated immediately after sterilization and may not be stored temporarily!

⚠ **Please note:**

The user/dentist is responsible for the sterility of the VITA ENAMIC mesostructure.

It must be ensured that only suitable equipment and materials, as well as product-specific validated methods, are used for sterilization. The equipment that is used should be maintained properly and serviced regularly.



Screw attachment of the VITA ENAMIC mesostructure

⚠ **Note:** For screw attachment with the implant, please use the tools provided by the implant manufacturer and observe the specified torques.

- Seat the VITA ENAMIC mesostructure intraorally into the implant.
- Manual insertion of the corresponding implant screw.



- Tighten the implant screw using a torque wrench (observe the specifications provided by the manufacturer!).



- Insert a sterile wadding pellet, foam pellet or Teflon tape into the screw channel using a spherical plugger.
- Seal the screw channel using a temporary composite. This facilitates subsequent access to the screw.

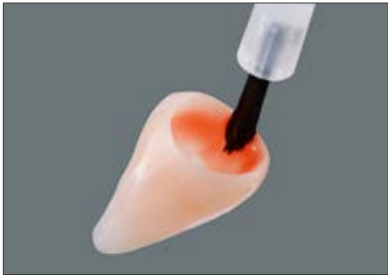

Conditioning the VITA ENAMIC crown

Ideally, clinical try-in should be carried out prior to etching so that the bonding surface is not contaminated.

⚠ Note: Temporary seating of a VITA ENAMIC crown on the VITA ENAMIC mesostructure is contraindicated.

- Use alcohol to degrease the restoration before it is seated.
- Apply VITA ADIVA CERA-ETCH (hydrofluoric acid gel, 5%) to the inner surfaces.

Etching time: 60 sec.



- Completely remove any remaining acid by spraying with water (60 seconds) or clean in the ultrasonic bath. Then dry for 20 seconds. Do not brush off as there is a risk of contamination! After drying, the etched surfaces have a whitish opaque appearance.



- Apply silane bonding agent (such as ADIVA C-PRIME from VITA, Monobond Plus from Ivoclar Vivadent or CLEARFIL CERAMIC PRIMER from Kuraray) to the etched surface.
- Depending on the adhesive composite used, apply bonding agent as appropriate and blow with air. Do not light cure! Place ready for insertion without exposure to light.

⚠ Note: Please observe the instructions for use for the selected bonding material.



Permanent bonding of the VITA ENAMIC crown on the VITA ENAMIC mesostructure

- Application of a suitable translucent adhesive bonding material, such as VITA ADIVA F-CEM or PANA VIA F 2.0 TC (Kuraray) into the preconditioned crown.



- Seating of the crown on the VITA ENAMIC mesostructure and fixation in the final position.



- Removal of excess bonding material.



- Coverage of the adhesive joint using suitable glycerin gel.

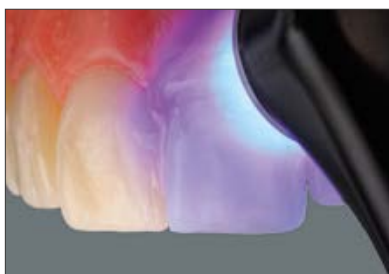

- Polymerization using an LED polymerization device.
- Remove glycerin gel using water.
- Verification of the occlusion and articulation and implementation of corrections, as appropriate. If the restoration is milled, these areas must then be polished again to a high-gloss finish (in the case of VITA ENAMIC, specifically using the VITA ENAMIC Polishing Set clinical).

Verification of the restoration margins or the adhesive joint. Possible removal of excess adhesive composite.



Finishing and polishing (intraoral)

- Pay attention to margins and contact points when finishing and polishing the restoration. The correct speed must be ensured and generation of heat must be avoided.
- Check for any excess material, finish with fine-grained Sof-Lex discs (3M ESPE) or files for an EVA system.

Fine morphological adjustments

- The occlusion / articulation must be completely free of interference. Remove unwanted contacts using diamond burs (40 µm).
- In order to achieve a natural surface shine, two steps are required.

The following applies specifically for VITA ENAMIC:



- Prepolishing using the pink polishers of the VITA ENAMIC Polishing Set (7,000 – 10,000 rpm), while cooling with water.
- While cooling with water, polish to a high-gloss finish using the grey diamond polishers of the VITA ENAMIC Polishing Set (5,000 – 8,000 rpm).
- Work using reduced contact pressure!



⚠ **Tip:** Final polishing to a high-gloss finish at the lowest speed and without cooling with water. If Sof-Lex polishing discs are used for finishing and prepolishing, use only the medium grain (M) and very fine grain (SF) types.









- Completed VITA ENAMIC crown with VITA ENAMIC mesostructure in situ.

Overview of the process steps for intraoral bonding of the VITA ENAMIC crown with the VITA ENAMIC mesostructure

| | Process steps | VITA ENAMIC Mesostructure | VITA ENAMIC crown |
|----|---------------------------------|--|--------------------------|
| 1. | Cleaning the surface | Ethanol | Ethanol, ultrasonic unit |
| 2. | Etching (extraoral) | VITA ADIVA CERA-ETCH, 5% HF, 60 s | |
| 3. | Cleaning the surface | Use water, either by spraying off or in an ultrasonic bath | |
| 4. | Conditioning/silanizing | Apply VITA ADIVA C-PRIME, for example, and allow to dry | |
| 5. | Adhesive bonding | e.g., VITA ADIVA F-CEM | |
| 6. | Coverage of the adhesive joint | VITA ADIVA OXY-PREVENT | |
| 7. | Polishing of the adhesive joint | VITA ENAMIC POLISHING SET | |

| Recommended products | |
|---|--|
| <p>Ceramic etching gel for VITA ENAMIC VITA ADIVA CERA-ETCH, 5% hydrofluoric acid gel</p> <ul style="list-style-type: none">– Available as a syringe, 3 ml – Available as a dropper bottle, 6 ml |  |
| <p>Bonding agent/primer for VITA ENAMIC</p> <ul style="list-style-type: none">– VITA ADIVA C-PRIME, silane bonding agent, bottle, 3 ml – Monobond Plus (Ivoclar Vivadent) |  |
| <p>Bonding agent for VITA CAD-Temp</p> <ul style="list-style-type: none">– SR Connect (Ivoclar Vivadent) | |
| <p>Bonding agent / primer for titanium base</p> <ul style="list-style-type: none">– Monobond Plus (Ivoclar Vivadent) | |
| <p>Adhesive composite for VITA CAD-Temp and VITA ENAMIC on a titanium base</p> <ul style="list-style-type: none">– Multilink Hybrid Abutment (Ivoclar Vivadent) | |

| Recommended products | |
|--|--|
| <p>Adhesive composites for VITA ENAMIC crowns on a VITA ENAMIC mesostructure</p> <p>– VITA ADIVA F-CEM</p> |  |
| <p>Materials and bonding agents for individualization of VITA CAD-Temp and VITA ENAMIC</p> <p>– VITA VM LC/VITA VM LC flow, veneering composite</p> <p>– VITA VM LC Modelling Liquid, bonding agent 10 ml</p> |   |
| <p>Material for shade characterization of VITA ENAMIC</p> <p>– VITA ENAMIC STAINS KIT</p> |  |
| <p>Polishing instruments for VITA ENAMIC hybrid ceramic</p> <p>– VITA ENAMIC Polishing Set clinical</p> <p>– VITA ENAMIC Polishing Set technical</p> |   |
| <p>Material for coverage of the implant screw prior to sealing of the screw channel</p> <p>– Teflon tape</p> | |

- **How should the screw channel of the VITA CAD-Temp or VITA ENAMIC abutment crown be sealed following adhesive bonding?**

To seal the screw channel, insert a sterile wadding pellet, foam pellet or Teflon tape into the screw channel using a spherical plunger, and then apply a suitable bonding agent into the opening. Then seal tightly using a light-curing filling composite.

- **Would it be better to seal the emergence profile of the VITA ENAMIC mesostructure or the abutment crown using VITA ENAMIC Glaze, or to polish it to a high-gloss finish?**

The emergence profile should be polished as a surface with a high-gloss finish that reduces the accumulation of plaque.

- **Why must the TiBase titanium base be sandblasted with high-grade aluminum oxide (Al_2O_3) prior to bonding the superstructure? Is it also possible to sandblast with glass beads?**

Defined surface enlargement and mechanical roughness are only achieved by sandblasting the titanium base with Al_2O_3 prior to bonding the mesostructure or the abutment crown; in combination with the chemical compound (using a primer), this results in clinically reliable adhesive bonding between the mesostructure or the abutment crown and the TiBase. Glass beads are not suitable for this purpose.

⚠ Note:

- Dental treatment and the integration of dental restorations entail the general risk of iatrogenic damage to hard tooth substance, pulp and/or oral soft tissue. The use of bonding systems and the integration of dental restorations involve the general risk of postoperative hypersensitivity.
- In the event of non-compliance with the processing instructions of the products in use, the product characteristics can not be ensured so that product failure and irreversible damage to the natural hard tooth substance, pulp and/or oral soft tissue may result.

| Safety information (the following VITA products require hazard identification): | | |
|--|---|--|
| <p>VITA ADIVA® CERA-ETCH (hydrofluoric acid ceramic etching gel)</p> | <p>Caustic / toxic For extraoral use only! Contains hydrofluoric acid. Toxic if swallowed. Fatal in contact with skin. Causes severe skin burns and damage to eyes. Harmful by inhalation. Wear safety goggles/protective gloves/protective clothing. Keep locked up. If swallowed, call Toxicological Information Center immediately and provide safety data sheet. In case of contact with clothing/skin, remove contaminated clothing immediately and rinse with copious amount of water. Specific measures, see safety data sheet. In case of contact with eyes, rinse with water for a few minutes and consult a doctor/Toxicological Information Center. This material and its container must be disposed of as hazardous waste.</p> | |
| <p>VITA ADIVA® C-PRIME (Silane bonding agent)</p> | <p>Highly flammable liquid and vapor. Keep away from heat / sparks / open flame / hot surfaces. No smoking.</p> | |
| <p>VITAVM®LC (veneering composite) (contains 2-dimethylaminoethyl methacrylate, triethylene glycol dimethacrylate)</p> | <p>Causes skin irritation. Causes serious eye irritation. May cause an allergic reaction.</p> | |
| <p>VITAVM®LC flow (veneering composite) (contains 2-dimethylaminoethyl methacrylate, triethylene glycol dimethacrylate)</p> | <p>Causes skin irritation. Causes severe eye irritation. May cause allergic skin reactions. Harmful to aquatic life with long lasting effects</p> | |
| <p>VITAVM®LC MODELLING LIQUID (bonding agent) (contains triethylene glycol dimethacrylate)</p> | <p>Causes skin irritation. Causes severe eye irritation. May cause respiratory irritation. May cause allergic skin reactions.</p> | |
| <p>Protective clothing</p> | <p>When working with the product, wear suitable safety goggles/face protection, gloves and safety clothing. In the case of formation of dust, an extraction unit or a face mask must be used</p> | |

The corresponding safety data sheets can be downloaded at www.vita-zahnfabrik.com/sds.



With the unique VITA SYSTEM 3D-MASTER, all natural tooth shades can be systematically determined and perfectly reproduced.

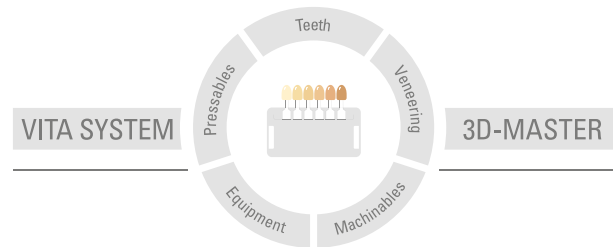

Please note: Our products must be used in accordance with the instructions for use. We accept no liability for any damage resulting from incorrect handling or usage. The user is furthermore obliged to check the product before use with regard to its suitability for the intended area of applications. We cannot accept any liability if the product is used in conjunction with materials and equipment from other manufacturers that are not compatible or not authorized for use with our product and this results in damage. The VITA Modulbox is not necessarily a component of the product. Date of issue of this information: 02.19

After the publication of this information for use any previous versions become obsolete. The current version can be found at www.vita-zahnfabrik.com

VITA Zahnfabrik has been certified and the following products bear the CE mark **CE 0124** :

VITA ENAMIC® · VITA CAD-Temp® · VITAVM®LC · VITAVM®LC flow

Manufacturer

VITA ADIVA® F-CEM, VITA ADIVA® C-PRIME:

Harvard Dental International GmbH, Margaretenstr. 2-4, 15366 Hoppegarten/
Germany, Tel.: +49 / (0)30 - 99 28 978-0

Harvard Dental International GmbH has been certified in accordance with the Medical Device Directive and the following products bear the CE mark **CE 0124**:

VITA ADIVA® F-CEM, VITA ADIVA® C-PRIME

Rx Only

CEREC® and inLab® are registered trademarks of Sirona Dental Systems GmbH, Bensheim, Germany. Multilink® Hybrid Abutment, Monobond® Plus and Tetric EvoFlow® are registered trademarks of Ivoclar Vivadent AG, Schaan, Liechtenstein. Clearfil® and Clearfil Majesty® are registered trademarks of Kuraray Europe GmbH, Hattersheim, Germany. Sof-Lex® and Filtek® are registered trademarks of 3M Company or 3M Deutschland GmbH.

[1]* Please contact the manufacturer of your implant to obtain system-related recommendations.

[2]* "Clinical aspects of all-ceramics", VITA Zahnfabrik, Order No. 1696.

VITA

VITA Zahnfabrik H. Rauter GmbH & Co. KG
Spitalgasse 3 · D-79713 Bad Säckingen · Germany
Tel. +49 (0) 7761/562-0 · Fax +49 (0) 7761/562-299
Hotline: Tel. +49 (0) 7761/562-222 · Fax +49 (0) 7761/562-446
www.vita-zahnfabrik.com · info@vita-zahnfabrik.com
 facebook.com/vita.zahnfabrik